

EXPLORING MAGNETISM



What is a Magnet?



What Materials are Magnetic?

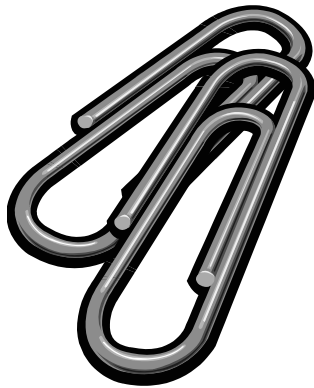

What Materials are Magnetic?



Fe Iron
Atomic Number: 26
Atomic Mass: 55.85

Co Cobalt
Atomic Number: 27
Atomic Mass: 58.93

Ni Nickel
Atomic Number: 28
Atomic Mass: 58.96

Magnets and magnetic materials

Magnets attract objects made of magnetic materials



Magnetic materials include the elements **iron, nickel, cobalt**, alloys containing some of these such as **steel** and some of their compounds.



iron



nickel



cobalt



stainless
steel

Hard and soft magnetic materials

Permanent magnets

are made of magnetically **HARD** materials such as **steel**. These materials retain their

magnetisation once



Magnetically **SOFT** materials, such as iron, lose their magnetisation easily. They are suitable for temporary magnets such as **electromagnets**.



What Do Magnets Do?

✓ **Attract or repel other magnets (exert a force)**

✓ **Attract other magnetic metals**

✓ **Have at least 2 distinct ends (poles) each**

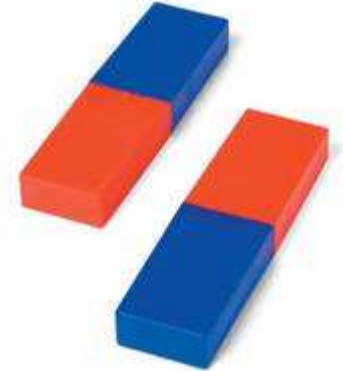

Like poles repel, opposite poles attract

Notes:

▪ **Do not need to touch to exert force (can exert force through empty space)**

▪ **Can turn other magnetic metal objects into temporary magnets**

Magnetic poles

Magnetic poles are the parts of a magnet that exert the greatest force.

Magnetic poles occur in pairs usually called **north (N)** and **south (S)**



Iron filing are attracted mostly to the poles of a magnet

Why poles are called **north** and **south**

A magnet suspended so that it can rotate freely horizontally will eventually settle down with one pole facing north and the other south.

This pole is therefore called the '**north seeking pole**', usually shortened to just '**north pole**'.

The magnet has been orientated by the Earth's magnetic field.

A **compass** is an application of this effect.

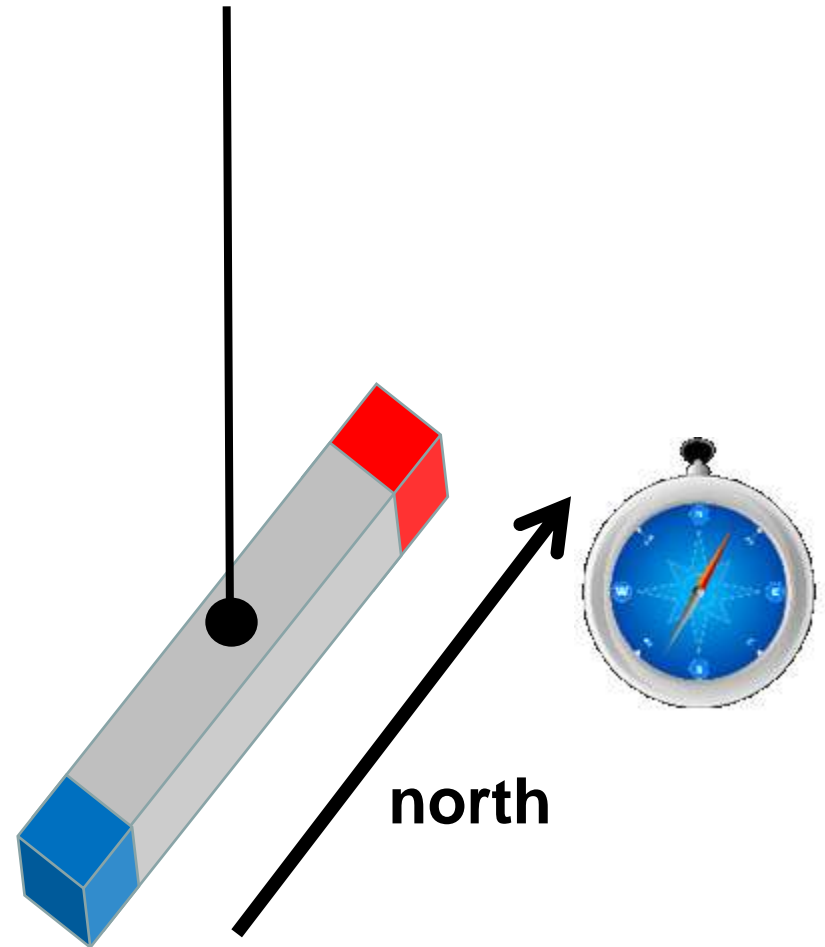

The law of magnets

Like poles repel **unlike poles attract**

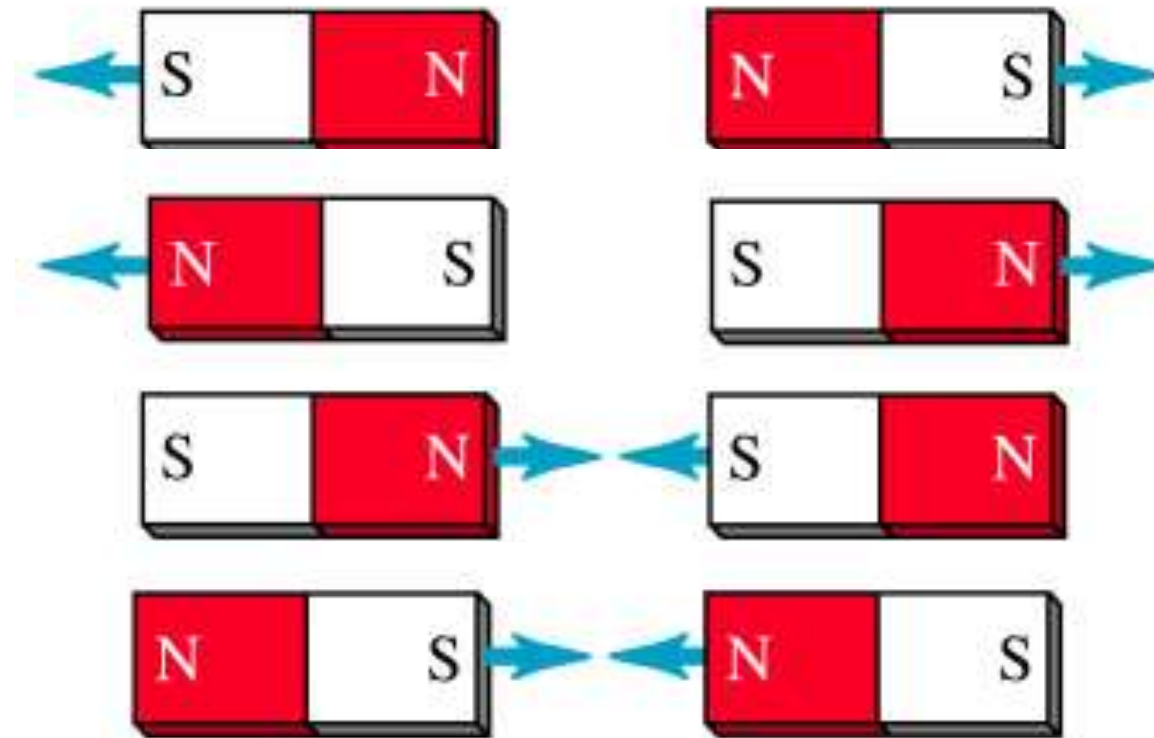

Magnetism in a Magnet

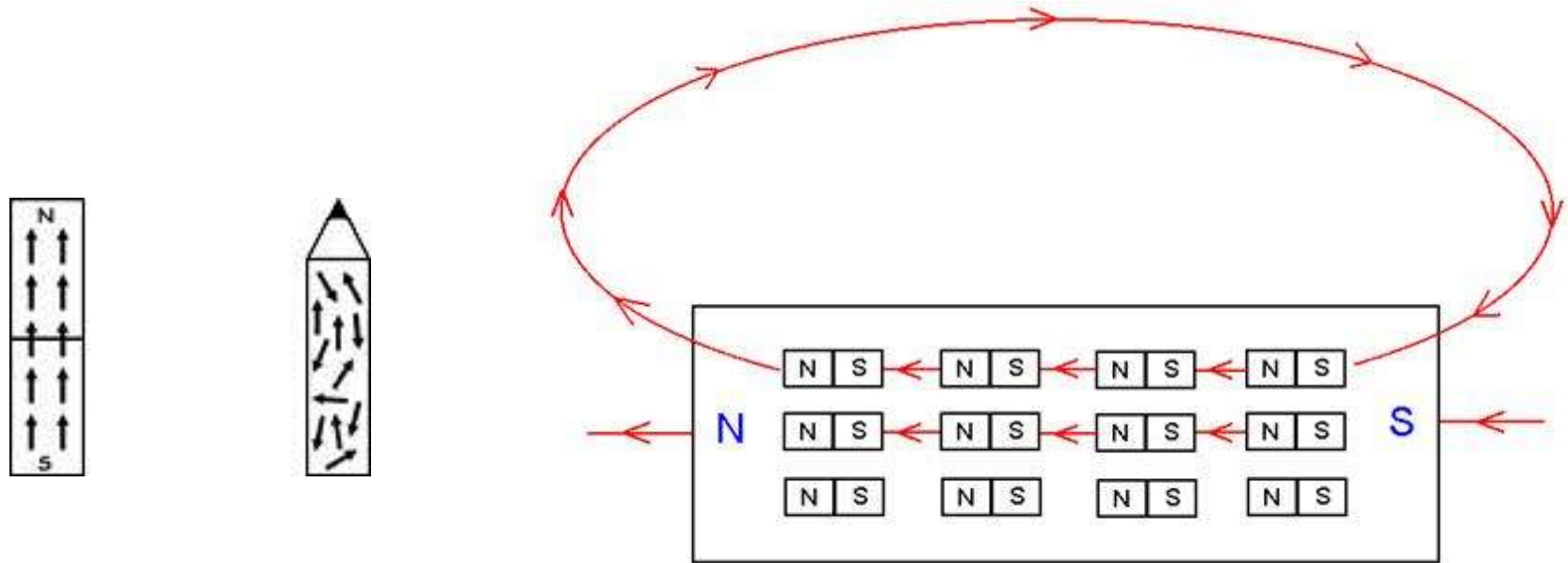

When elements like Fe form solids, they form crystalline structures with little domains of many, many atoms all aligned. Each domain is like a mini-bar magnet. When all the domains are allowed to align, the whole object takes on a large-scale magnetic field.

Earth: A Huge Bar

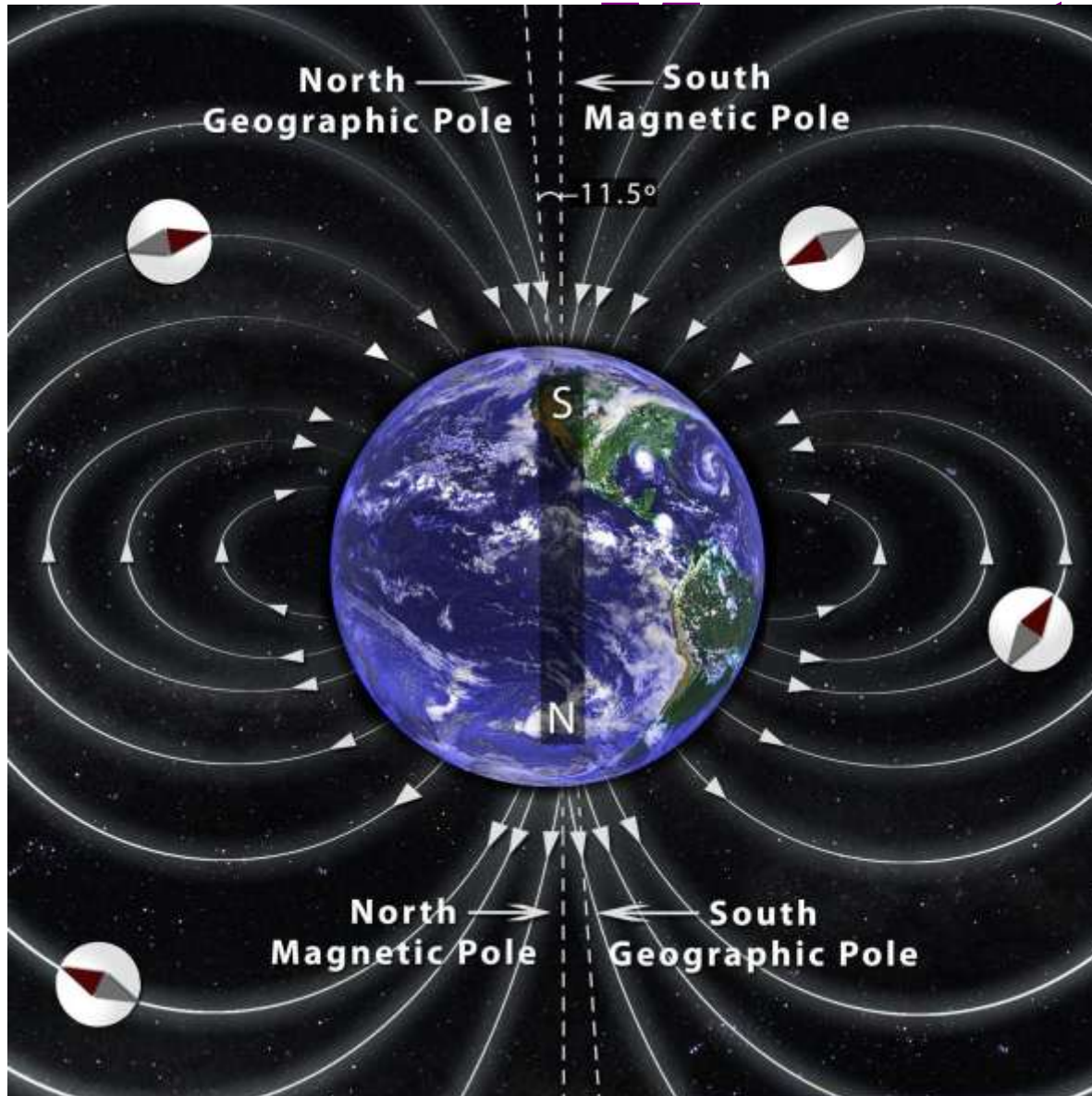

Moving molten iron in Earth's outer core causes most of Earth's magnetic field.

Magnetic field poles are NOT aligned with geographic poles. They also wander and flip (500,000 yrs between flips, 10,000 yrs to

What is a Force?

Force is a push or pull that causes a change in motion.

A Force Field is the pattern in space of how that force is felt by other objects.

Fundamental Forces arise from fundamental properties of matter:

***Gravity* arise from Mass: mass attracts mass**
***Electric* force arises from Charge: two kinds of charge (positive and**

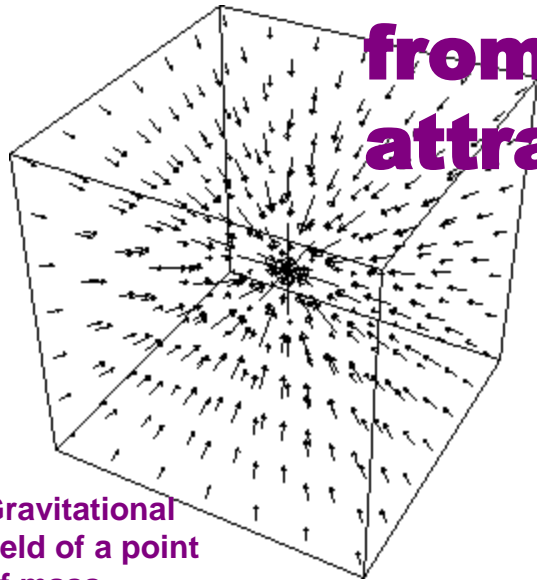

Gravitational field of a point of mass

Electric field of 2 like charges

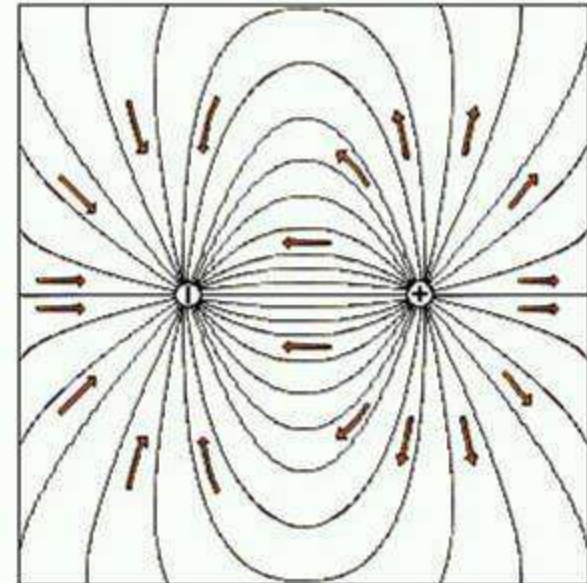
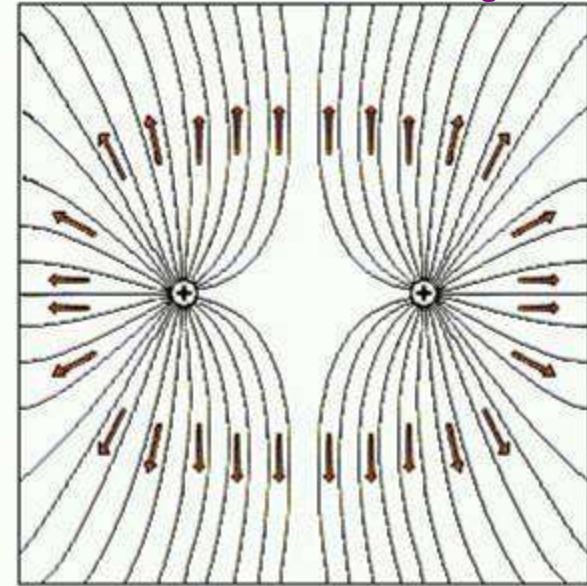

Electric field of 2 opposite

Magnetic Field

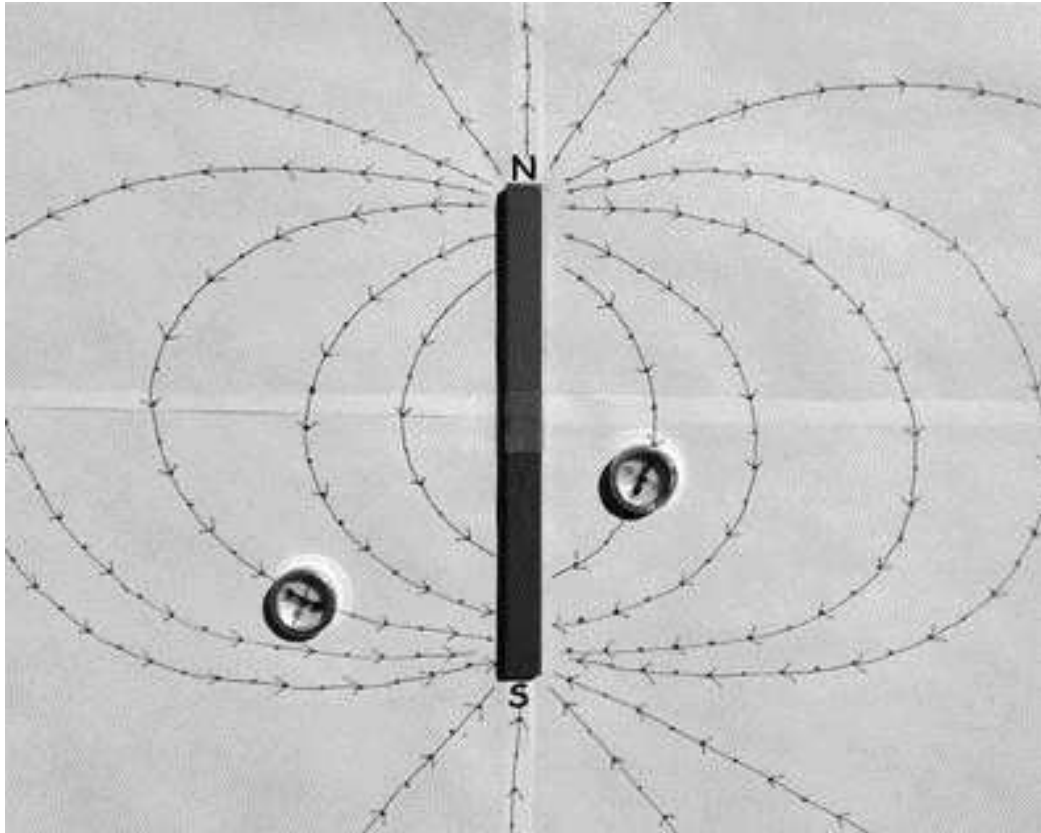

Magnetic field of a Bar Magnet: 2 poles, called North and South

Dipole field

Field has direction: lines point away from N and toward S

Definition of a Pole: Where lines meet (converge)

e.g.: lines of longitude on a globe meet at poles

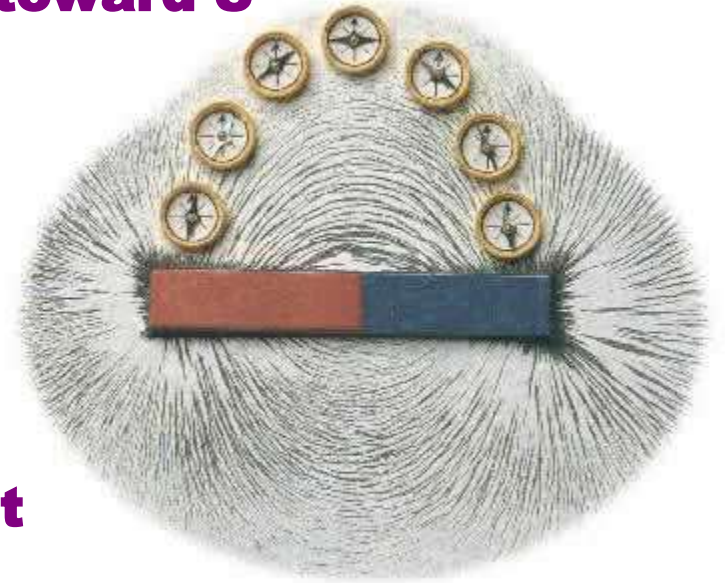

Very Early History of Magnetism

some anecdotal

- 1400 BC - Compass used in China
- 900 BC - Magnus, Greek shepherd, black stones which pull the iron nails out of his sandals (authenticity not guaranteed). This region becomes known as Magnesia.
- 1269 - Pierre Marincourt (France) natural spherical magnets (lodestones) align needles with lines of longitude pointing between two pole positions on the stone. Defines “poles”
- 1300’s Navigational compasses in Europe
not sure when sailors started to use navigational compasses – Columbus had one. Magnetized needle or lodestone floating on a cork in water



Model of compass used in China about 450 BC. The reference direction was south

- gift from AFML



Early European
Compass
From De Magnete

Breakthrough in Understanding Magnetics

16th C, William Gilbert

- Understanding of the compass
- Description of “poles”
- The earth acted as a single large magnet
- Induced magnetism

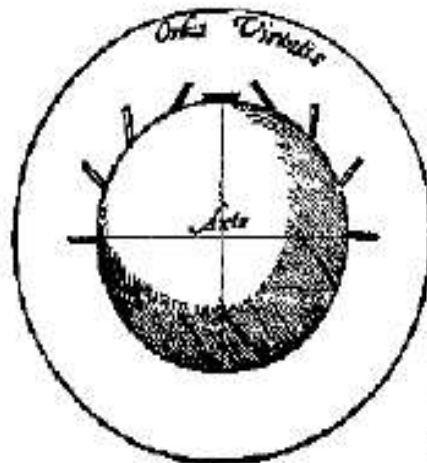

Gilbert's model of the earth's magnetism

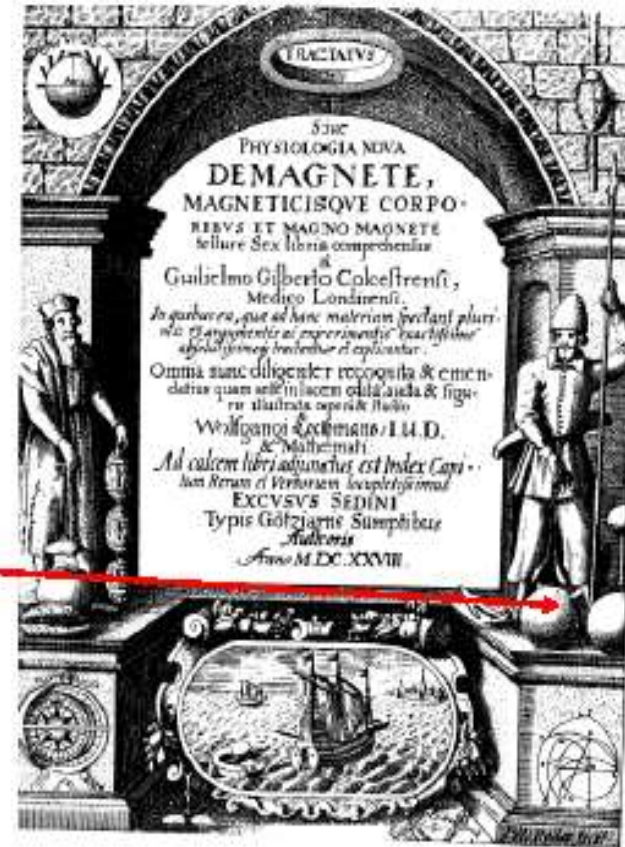

Front page of De Magnete

1820, Hans Oersted



- ...connected a battery to let electric current flow, and noticed a compass needle twitch and move.

Oersted's Experiment



Hans
Christian
Oersted
(1777-1851)

Hans Christian Oersted discovered in 1820 that an electric current near a compass causes the compass needle to be deflected. Oersted's experiment showed that every electric current has a magnetic field surrounding it.

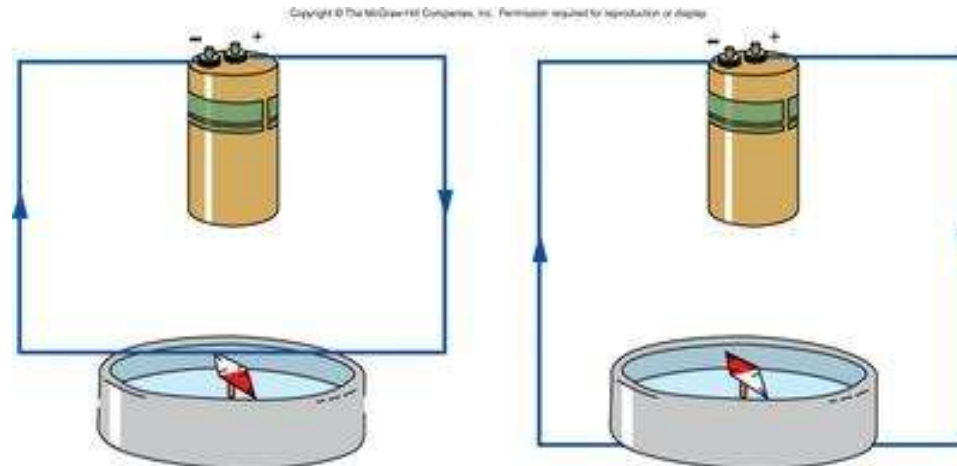

Oersted's Experiment

According to the **right-hand rule**, the electron current in a wire and the magnetic field it generates are perpendicular to each other.

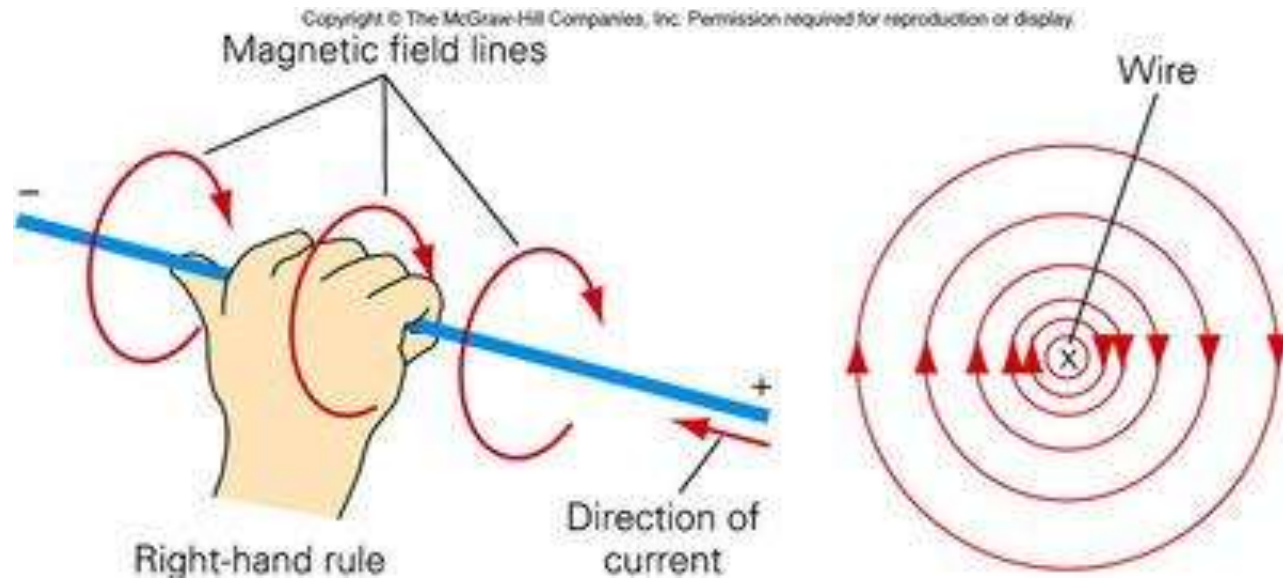

Oersted's Experiment

All magnetic fields originate from moving electric charges. A magnetic field appears only when relative motion is present between an electric charge and an observer. Electric and magnetic fields are different aspects of a single electromagnetic field.

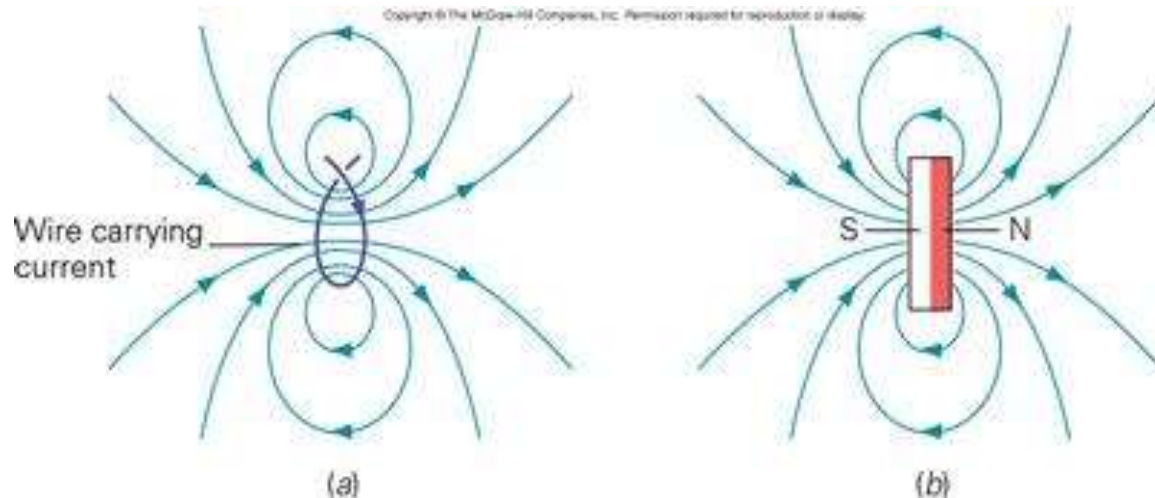

Electricity and Magnetism

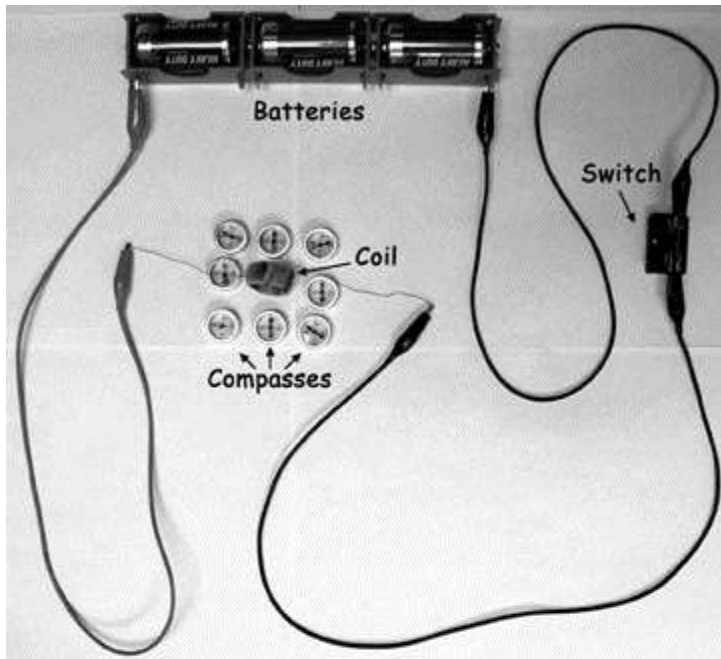

Electric Current (Electricity) is moving charge.

In an electric circuit, batteries provide an electric field to push charges through a wire, which provides a path for them to flow. Unless there is a complete circuit the charges cannot flow.

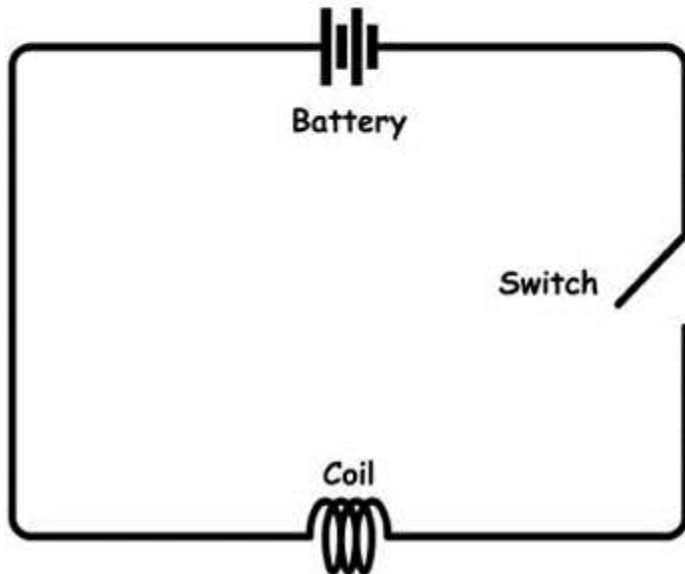

Compasses around a circuit with flowing electric current detect a magnetic field.

Magnets can push or pull on a wire with current flowing through it.

Electricity and Magnetism

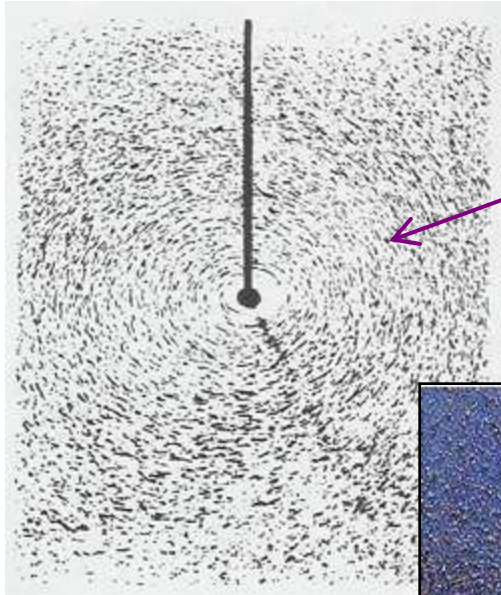

Looping the wire turns the magnetic field into

The shape of the magnetic field around a long, straight wire carrying electrical current

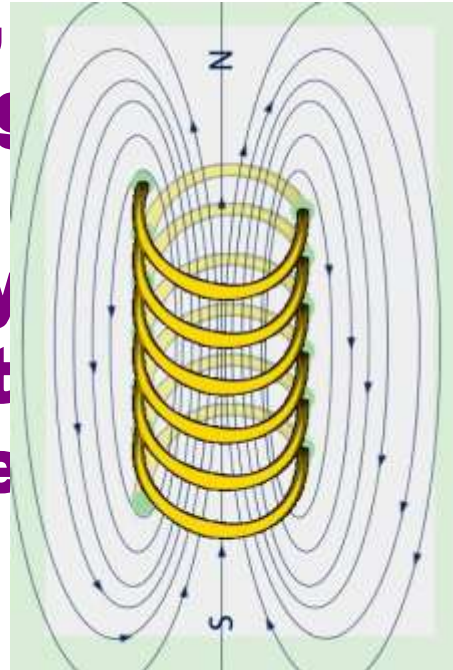
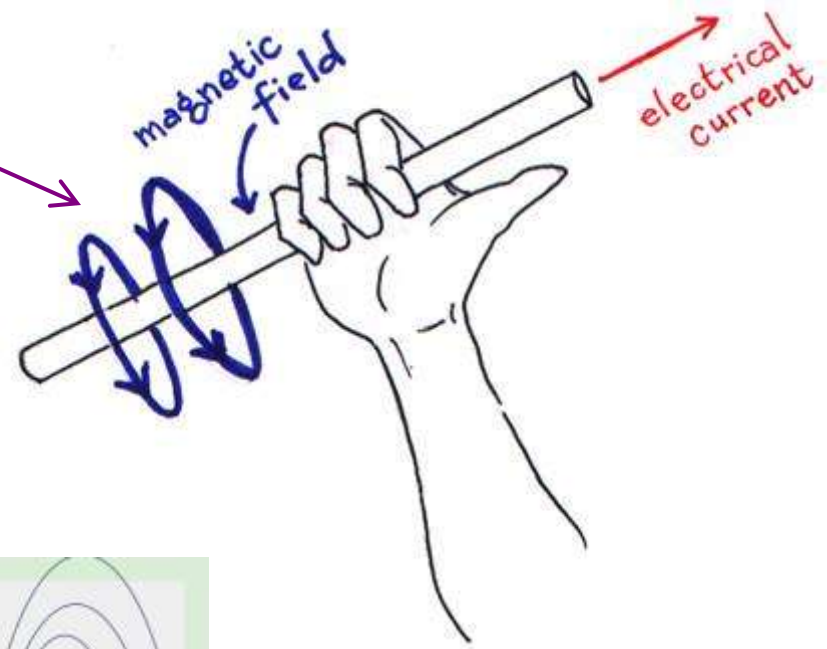

Many loops in a solenoid shape creates a dipole-shaped magnetic

Electricity and Magnetism

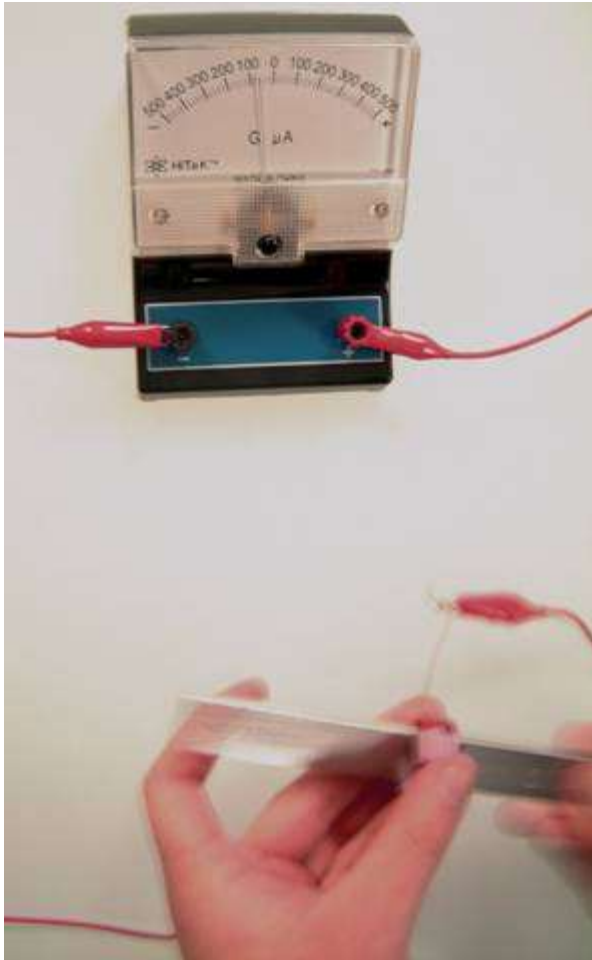

A dynamic electric field creates a magnetic field.

A dynamic magnetic field creates an electric field.

The basic principle behind electric generators is creating relative motion between a magnet and a wire to create an electric field that will push current through a circuit.

Converts kinetic energy into electric energy.

The genius of Faraday



- In London (in a lab I visited in 1997) **Michael Faraday (1791-1867), an unschooled bookbinder's assistant**, experimented with magnets and currents.
- In 1831 he observed that a moving magnet could induce a current in a circuit.
 - This is the inverse of Oersted's observation.
 - Somehow electricity and magnetism were intimately related!!!
- This became Faraday's law of induction and ultimately one of Maxwell's equations

$$\mathcal{E} = -\frac{d\Phi_B}{dt}$$

Other events of 1831

- Faraday also observed that a changing current could, through its magnetic effects, induce a current to flow in another circuit.

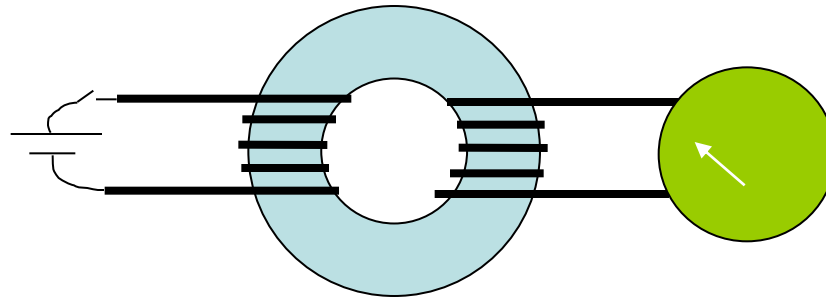

- If you spin a magnet inside a circuit it will generate current – **the electric generator**.

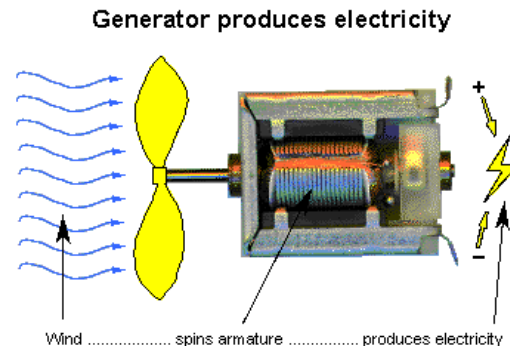

The real genius of Faraday

- Since he had no mathematical training but thought geometrically, he
- **invented the concept of fields of force.**
 - A geometric means of conceiving of what his experiments were showing him.
- This concept, this interpretation of what he saw is what set him apart from his predecessors.
- **It enables modern science!!!!**

Quantitative Relationships 1820-1900



Michael Faraday 1791-1867

- Induction
- Torque - Electric Motor
- Diamagnetism
- Effect on light



**Joseph Henry
1797-1878**

- Self Induction
 $H(\text{Henry}) \equiv V_s/A$ (unit
of induction)



**James Clerk Maxwell
1831-1879**

- Unifying theory of electricity and magnetism
- Molecular motion
- Unifying Thermodynamics

James Clerk Maxwell

- James Clerk Maxwell had the mathematical skills that Faraday lacked and used them to become **the greatest theoretician of the 19th century**.
- He graduated Edinburgh University at age 15 and became a full professor at Aberdeen University at age 17.
- In the 40 years (1839-1879) of his life he established the foundations of electricity and magnetism as
- **electromagnetics, established the kinetic theory of gasses, explained the rings of Saturn and experimented with color vision.**

Maxwell's symmetry and unification

- Two rules governed electricity and two other rules governed magnetism.
- Maxwell noticed that in these laws the electric field and the magnetic field appeared nearly symmetrically in the equations.
- For example, in Faraday's Law a time varying magnetic field gave rise to an electric field.
- In Ampere's law, as Maxwell modified it, a time varying electric field gave rise to a magnetic field.
- When made symmetric in electric and magnetic fields the set of four equations described them both, they described the subject we now call electromagnetism.
- **Electricity and magnetism had been unified into electromagnetism!**

Applications

1900 to current

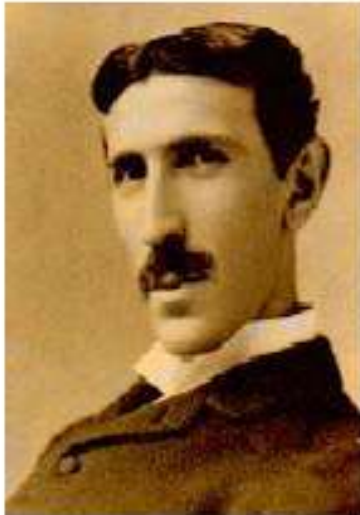

Nicola Tesla
1846-1943

- DC Magnetics
- Radiofrequency
- Power Transmission



Charles Steinmetz
1865-1923

- AC Magnetics
- Power Transmission
- Practical Induction Motors

MANY OTHERS

Magnetic Recording

Magnetic Memory

Inertial navigation

Magnetic field sensors

Micromotors

Sensors

Communication devices

Magnetic fields

A magnetic field is a volume of space where magnetic force is exerted.

All magnets are surrounded by magnetic fields.

The shape of a magnetic field can be shown by **iron filings** or **plotting compasses**.

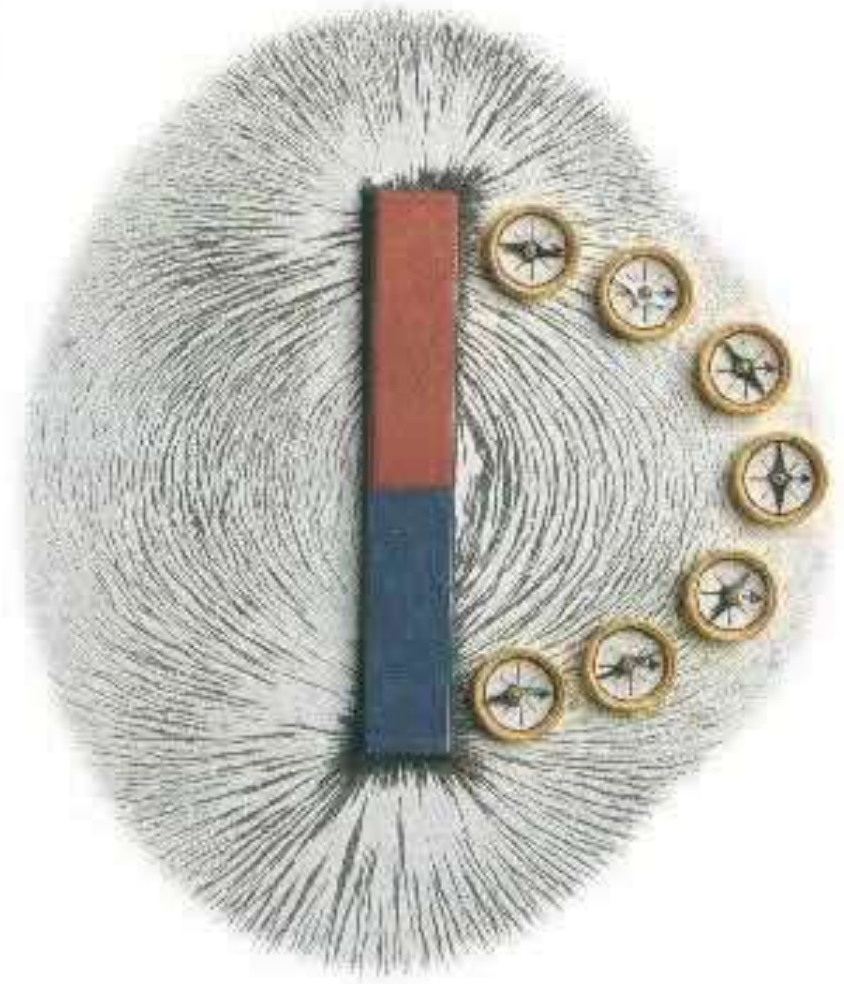

Magnetic field around a bar magnet

magnetic field line

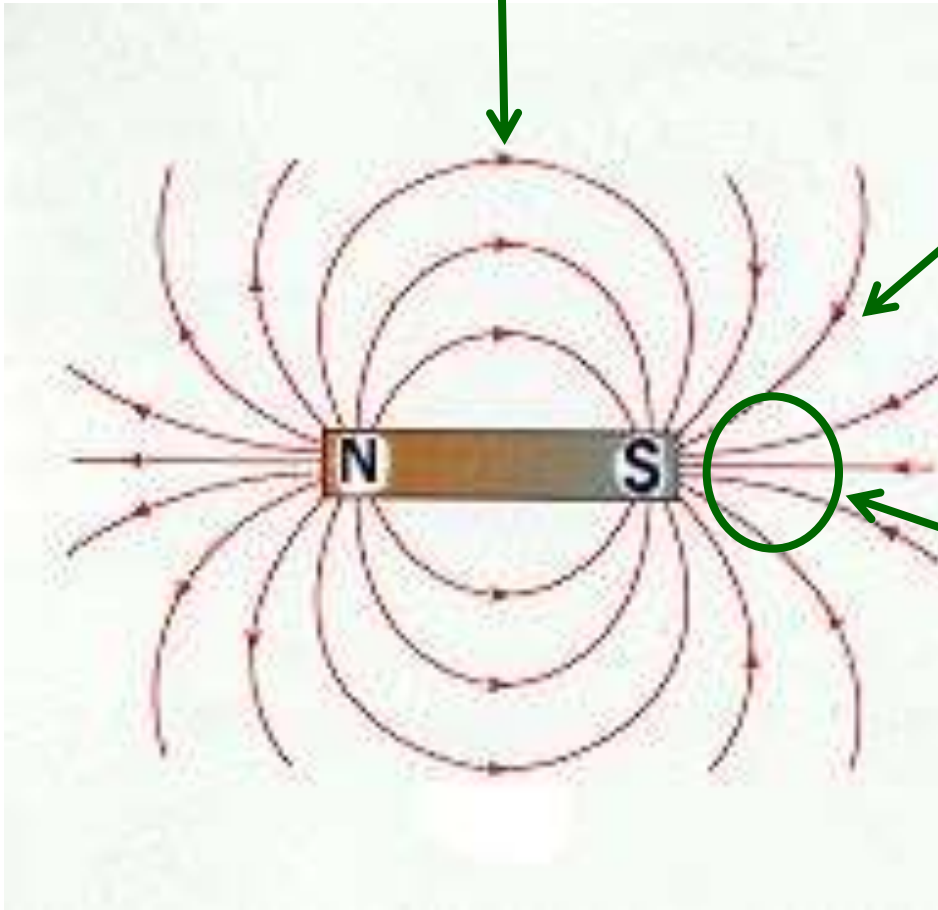

Arrows on the field lines show the direction of the force on a free to move north pole

The stronger the magnetic field the denser the magnetic field lines.

Magnetic fields between two bar magnets

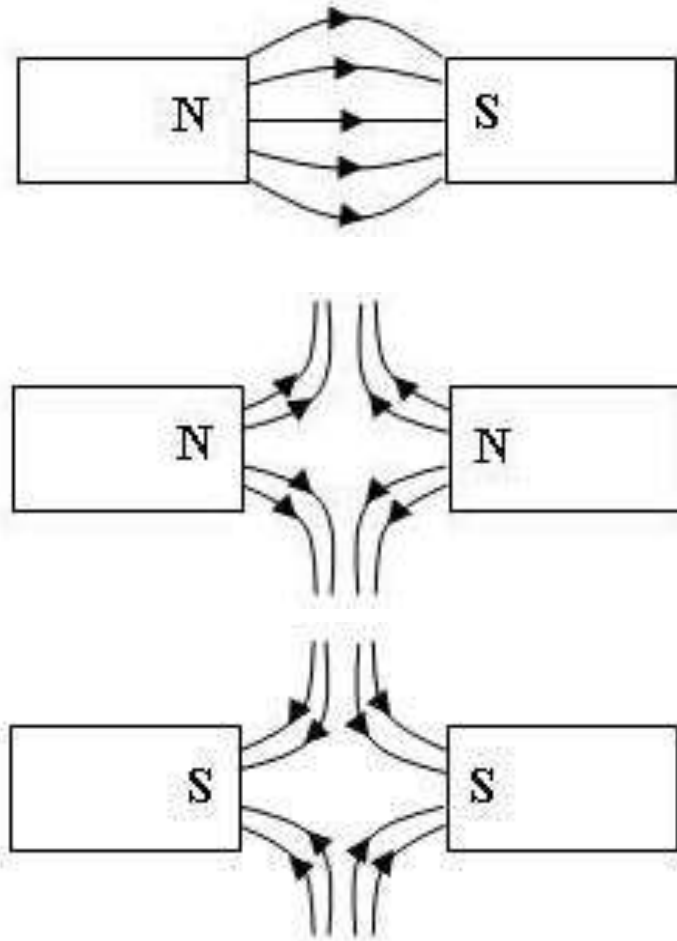

Producing a uniform magnetic field

A uniform magnetic field exerts a constant force over a region.

Such a field will consist of parallel equally spaced magnetic field lines.

This type of field can almost be found between a north and south magnetic pole.

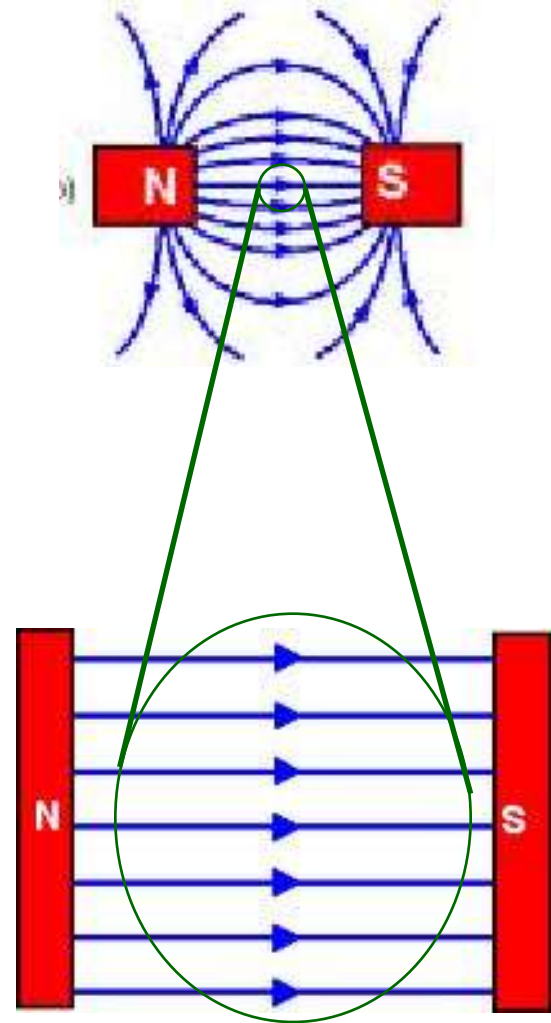

Induced magnetism

Magnetism can be induced in a magnetic material if it is placed within a magnetic field.

If the material is magnetically **hard** it will retain its magnetism once removed from the field.

Certain rocks in the Earth's crust such as **lodestone** have been magnetised in this way by the Earth's magnetic field.

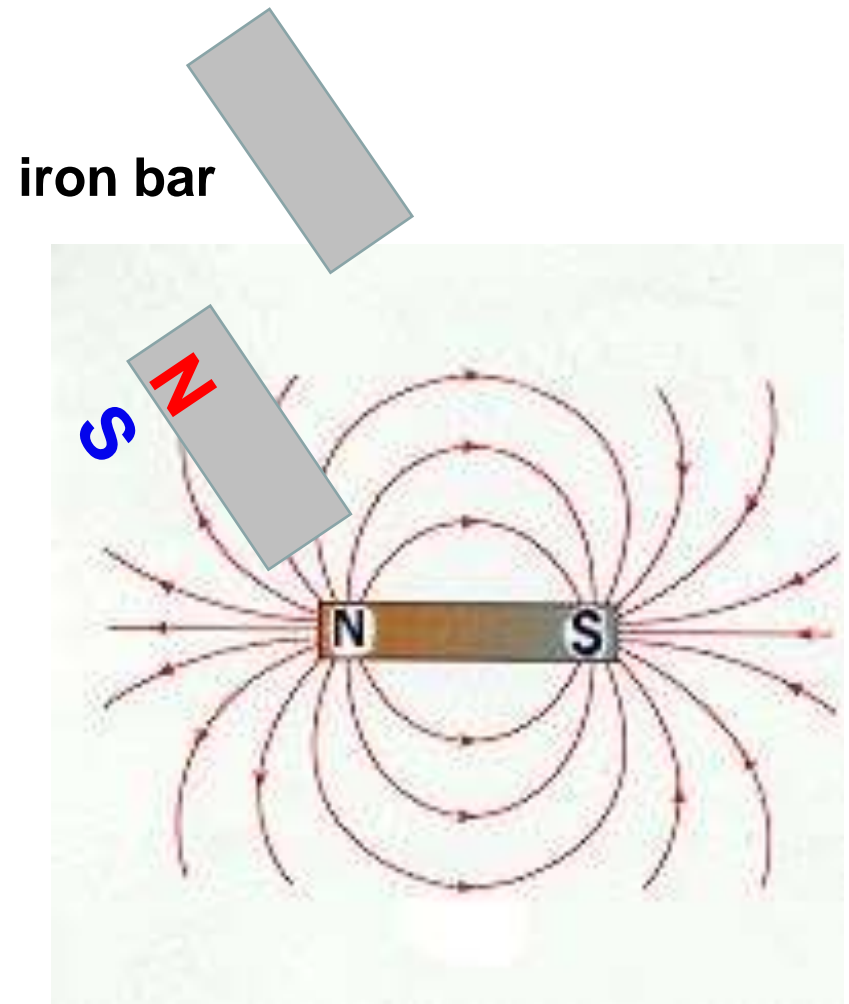

Magnets and Magnetic Fields

Magnetic fields can be visualized using magnetic field lines, which are always closed loops.

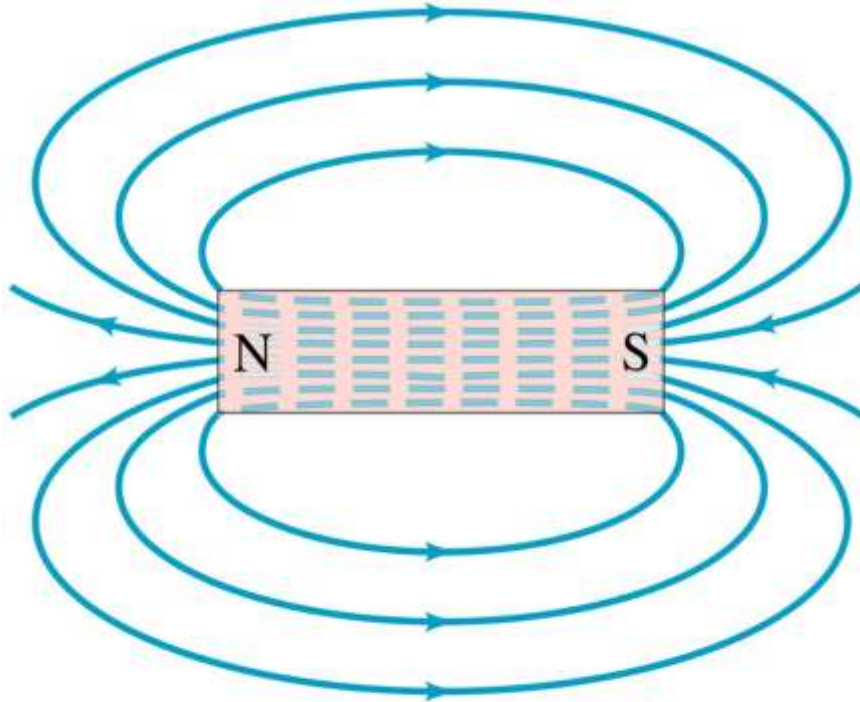

Notice that the magnetic field goes from North to South.

(b)

Magnets and Magnetic Fields

The Earth's magnetic field is similar to that of a bar magnet.

Note that the Earth's "North Pole" is really a south magnetic pole, as the north ends of magnets are attracted to it.

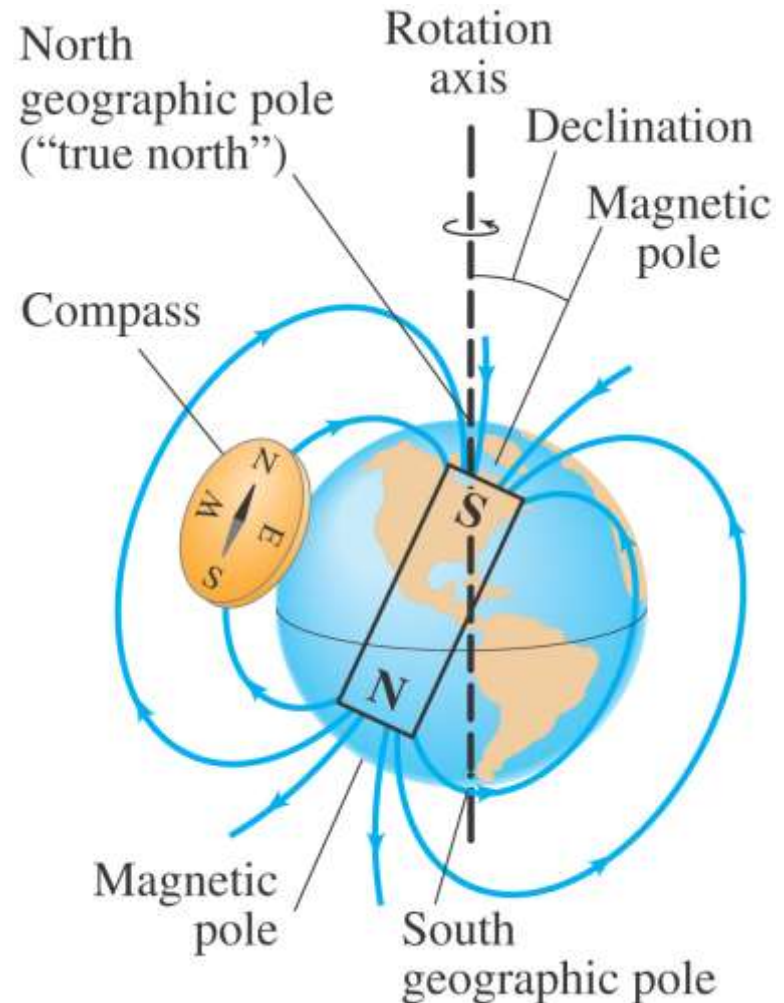

Magnets and Magnetic Fields

A uniform magnetic field is constant in magnitude and direction.

The field between these two wide poles is nearly uniform.

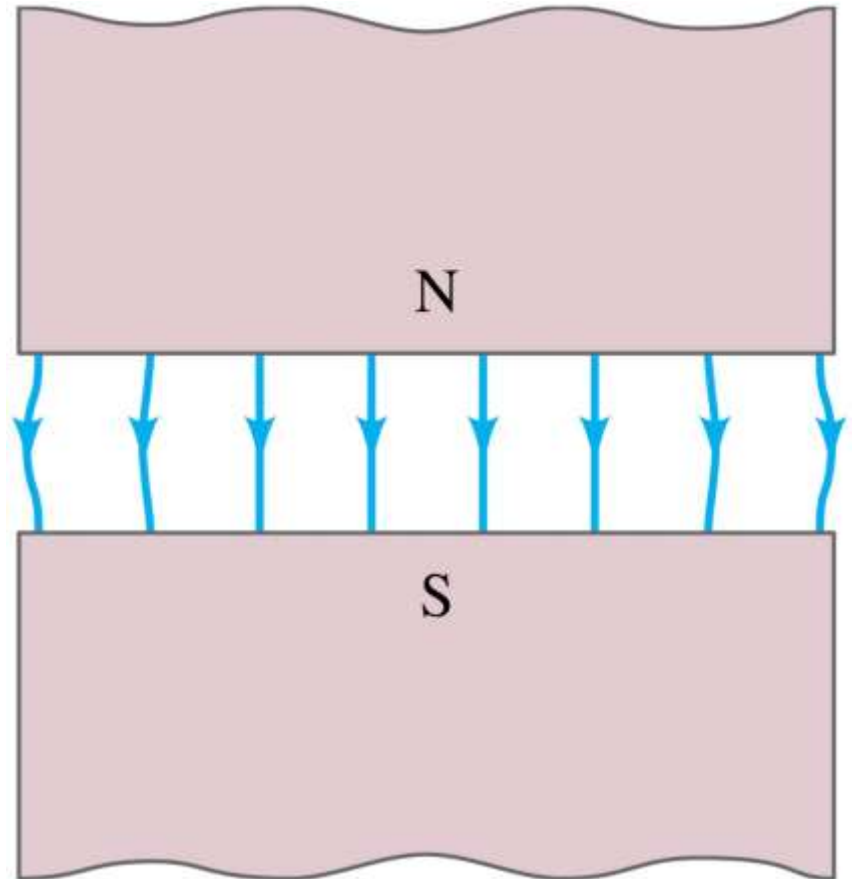

Electric Currents Produce Magnetic Fields

Experiment shows that an electric current produces a magnetic field. (Right Hand Rule)

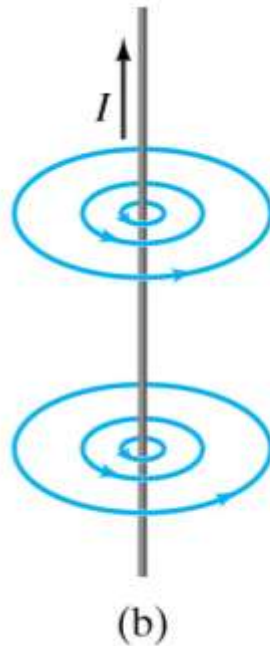

Magnetic field lines due to a circular loop of wire

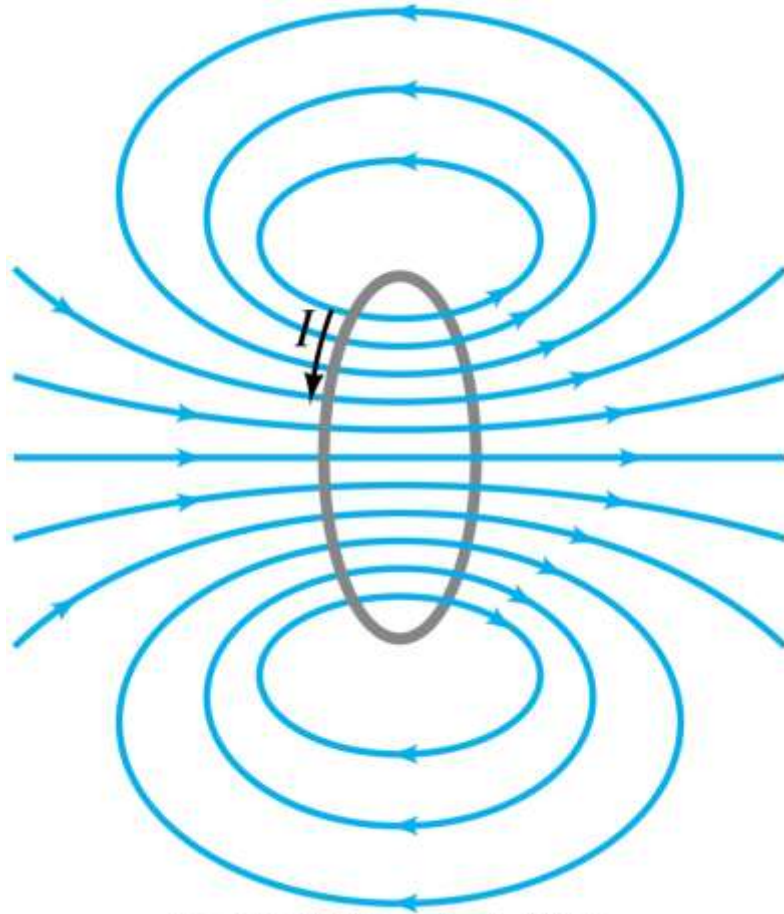

Copyright © 2005 Pearson Prentice Hall, Inc.

Electric Currents Produce Magnetic Fields

The direction of the field is given by a right-hand rule.

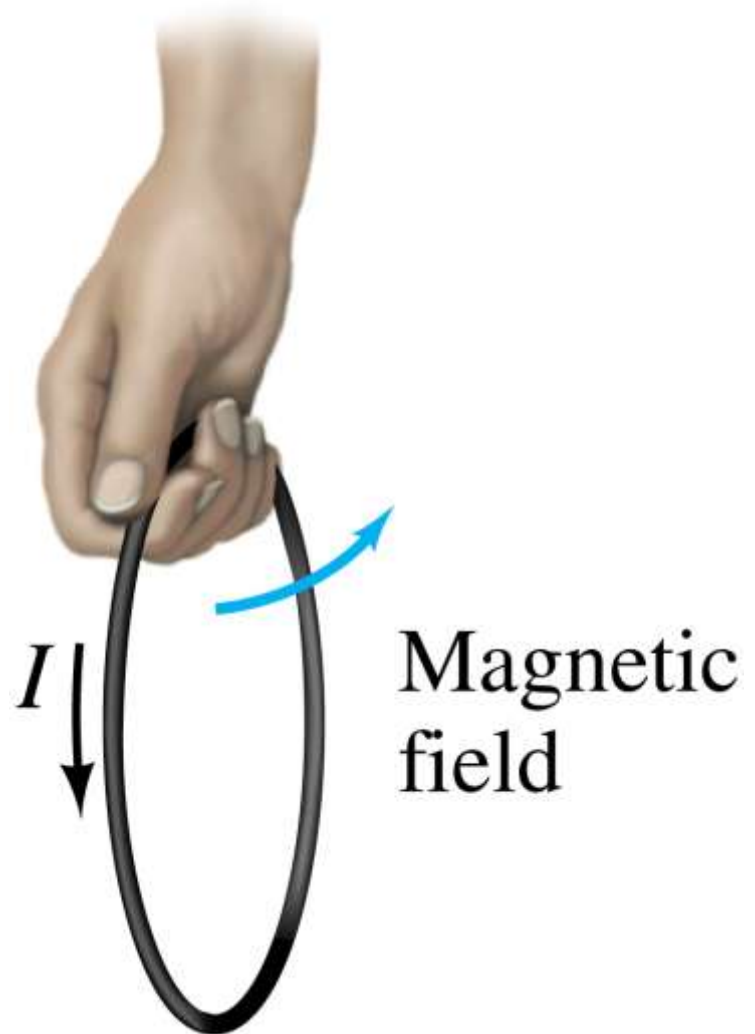

Force on an Electric Current in a Magnetic Field; Definition of \vec{B}

A magnet exerts a force on a current-carrying wire. The direction of the force is given by a right-hand rule.

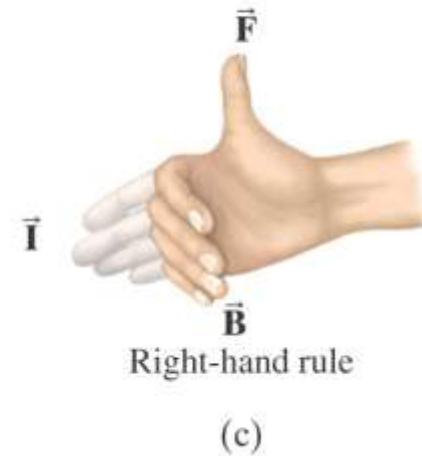
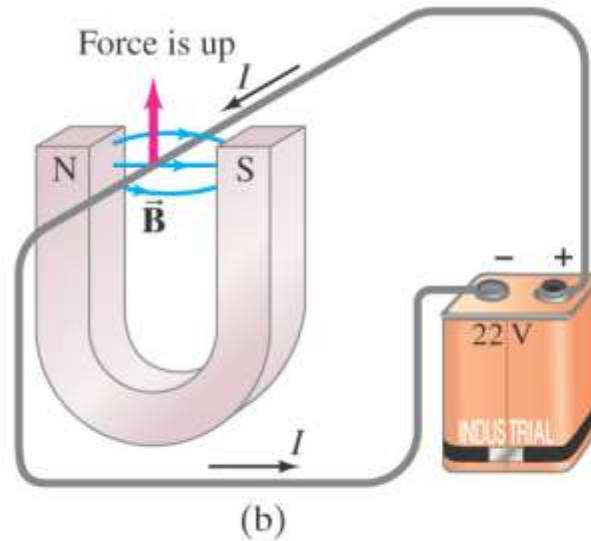
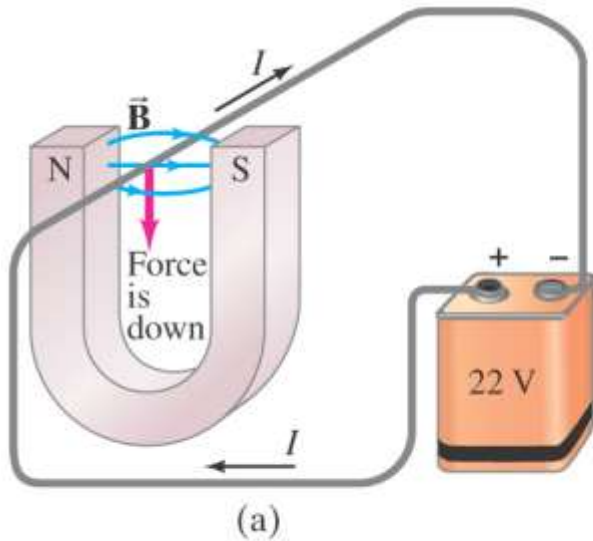

Magnetic Force on a Current

A magnetic field exerts a sideways push on an electric current with the maximum push occurring when the current is perpendicular to the magnetic field. Currents exert magnetic forces on each other. The forces are attractive when parallel currents are in the same direction and are repulsive when the parallel currents are in opposite directions.

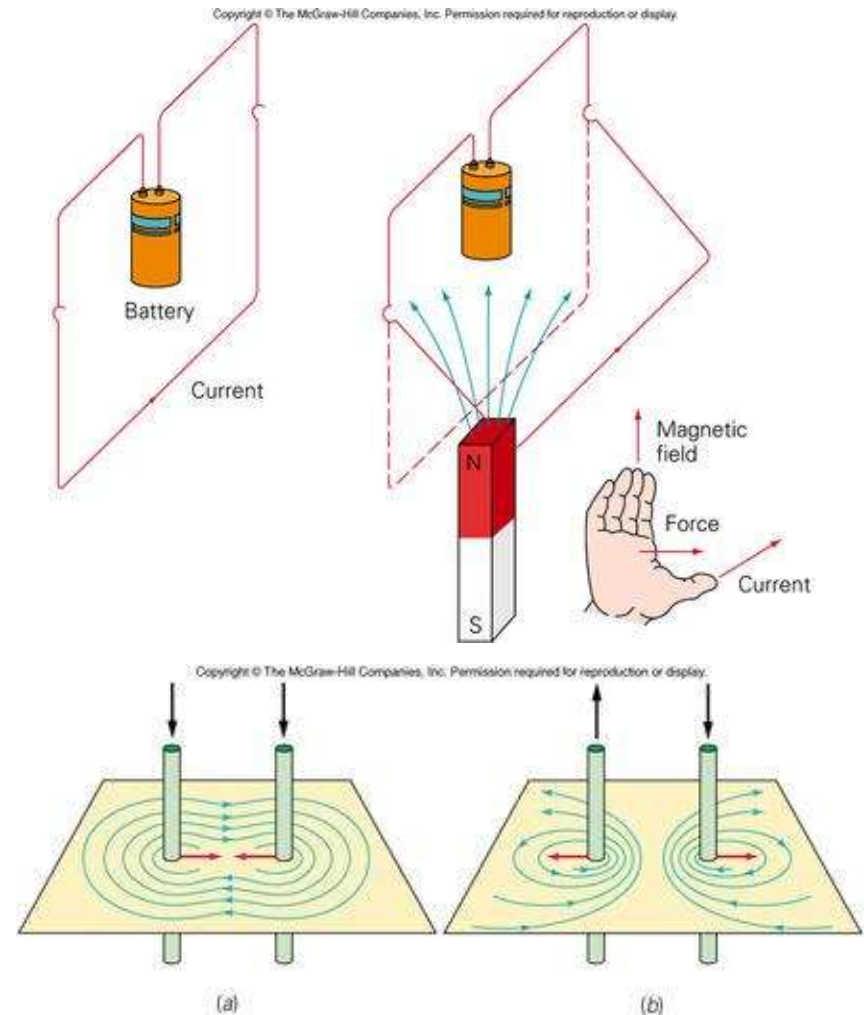

Copyright © The McGraw-Hill Companies, Inc. Permission required for reproduction or display.



Greg David / Corbis / Stock Market

The experimental Japanese Maglev train uses magnetic forces for both support and propulsion.

Magnetic field patterns around wires

1. Straight wire

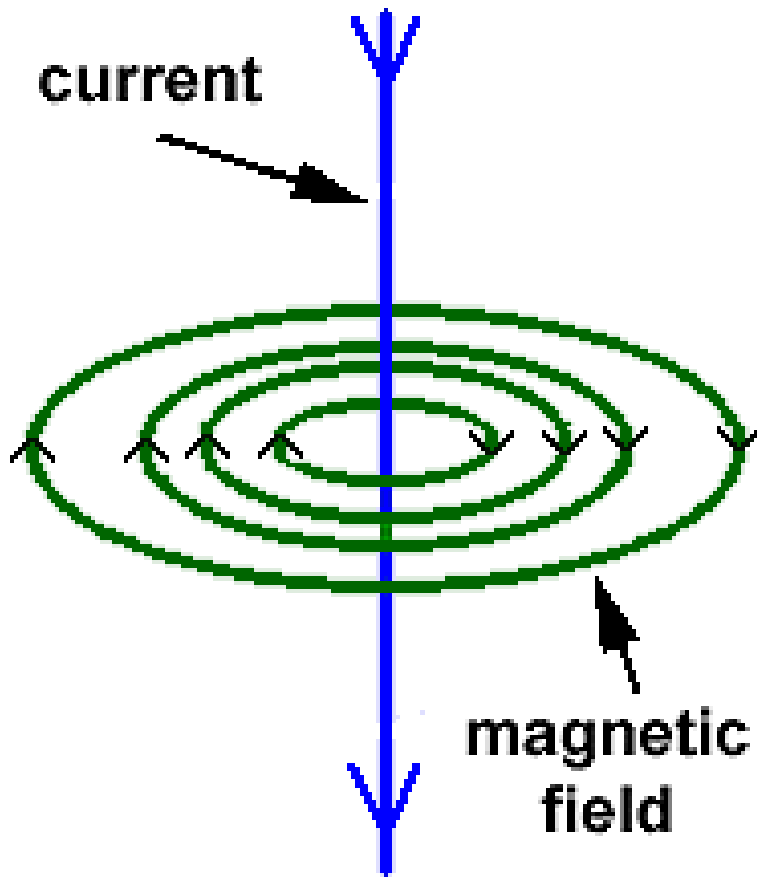

The magnetic field consists of concentric circles centred on the wire.

The magnetic field is strongest near the wire.

This is shown by the field lines being closest together near to the wire.

The strength of the field increases if the electric current is increased.

The right-hand grip rule (for fields)

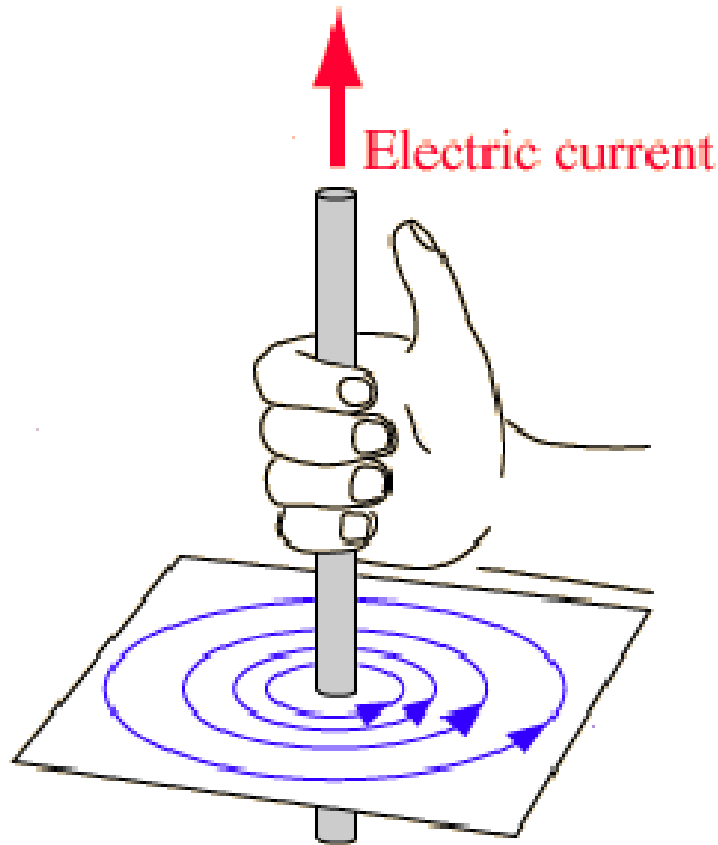

Grip the wire with the **RIGHT** hand.

The thumb is placed in the direction of the electric current.

The fingers show the direction of the circular magnetic field.

Complete the diagrams below:

**Add
field
arrow**

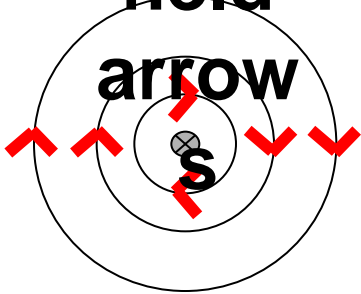

**Add
current
directio**



**Add
current
directio**

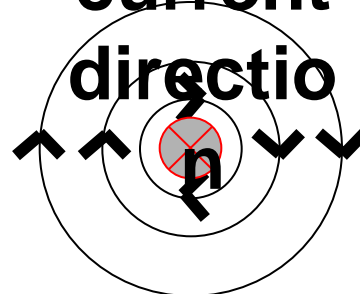

**Add
field
arrow**

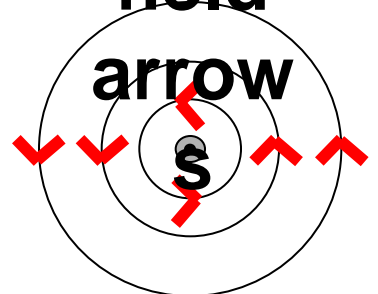

- **Electric current**
- ⊗ **into the page**
- ⊙ **out of the page**

2. Flat circular coil

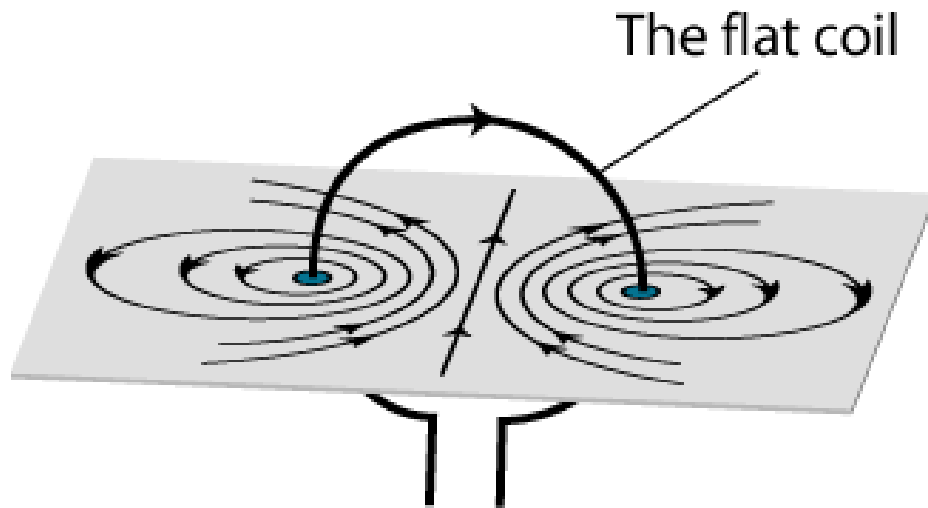

Magnetic field pattern
generated by a flat coil

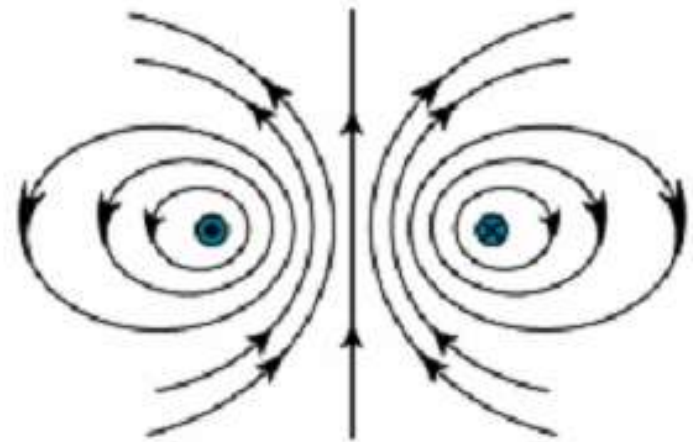

Plan view

3. Solenoid

A solenoid is a coil of wire carrying an electric current.

The magnetic field is similar shape to that around a bar magnet.

The strength of the field increases with:

1. the electric current
2. the number of turns in the coil

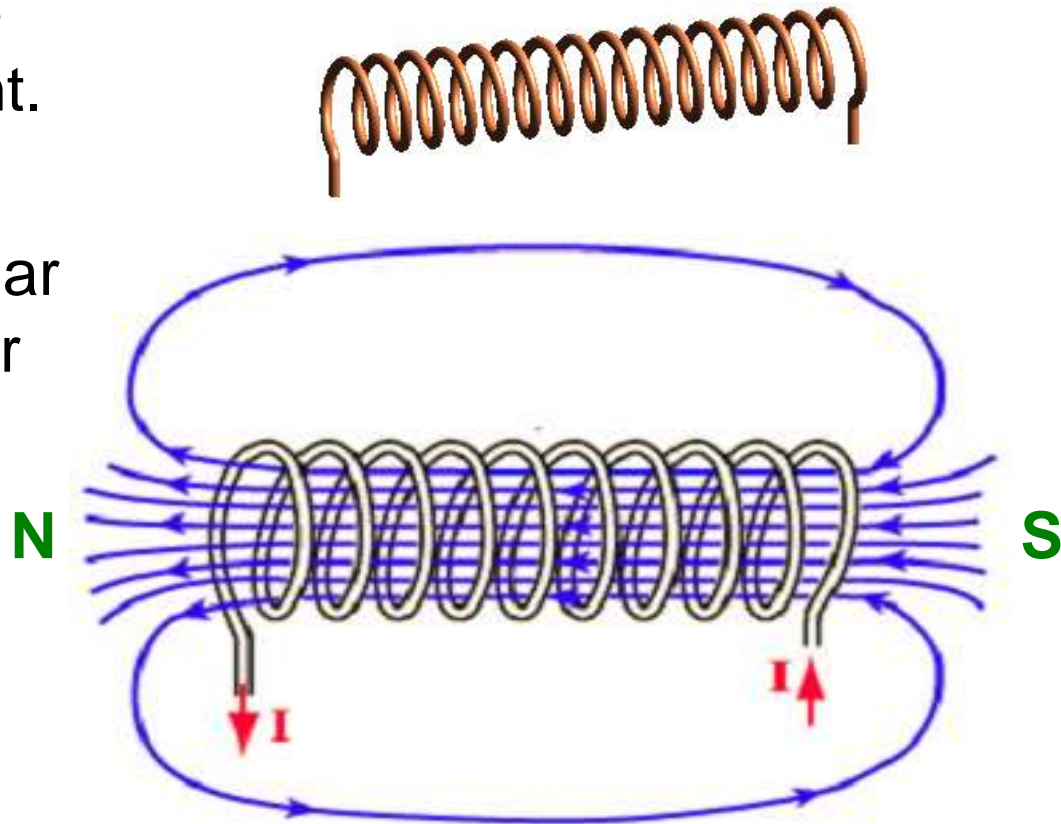

The right-hand grip rule (for poles)

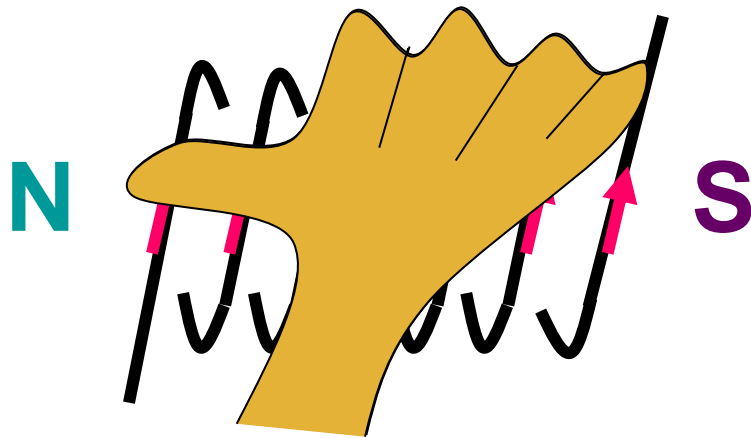

Grip the coil with the **RIGHT** hand.

The fingers are placed in the direction that the electric current flows around the coil.

The thumb points towards the north pole end of the coil.

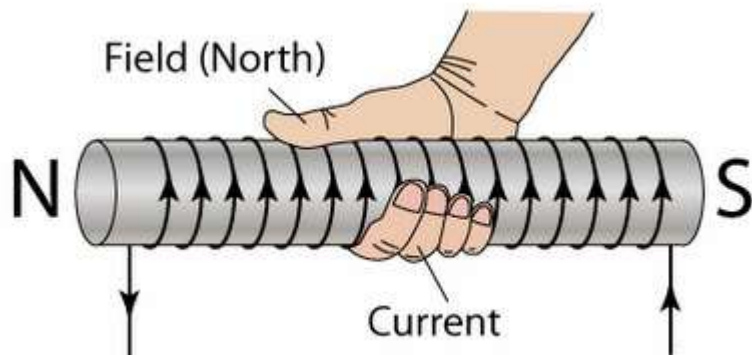

Complete the diagrams below:

1. Locate

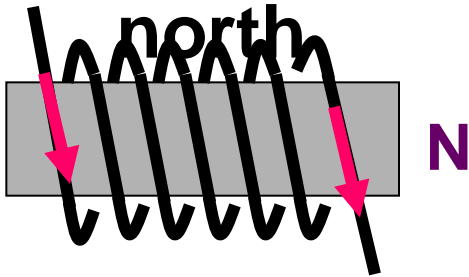

2. Locate

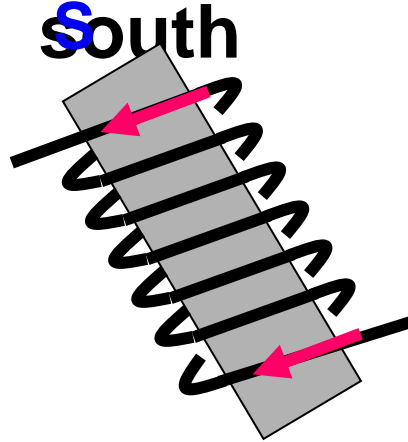

3. Add current direction

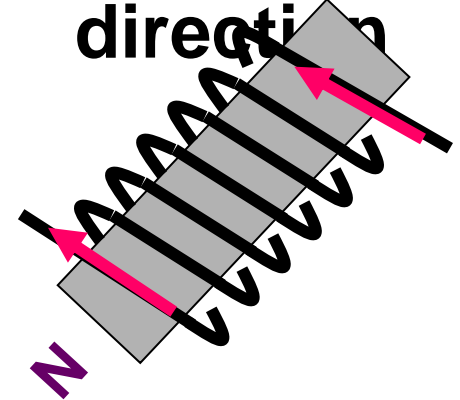

4. Add coils

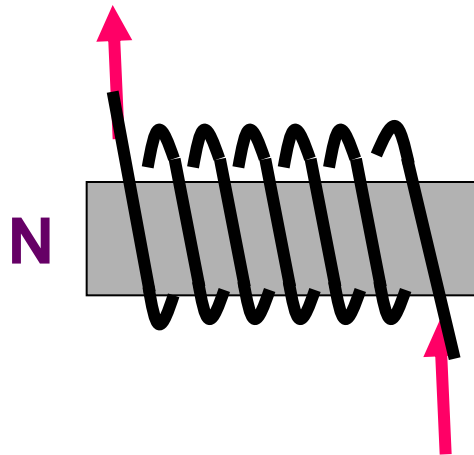

Current-carrying wire in a magnetic field. The force on the wire is directed into the page.

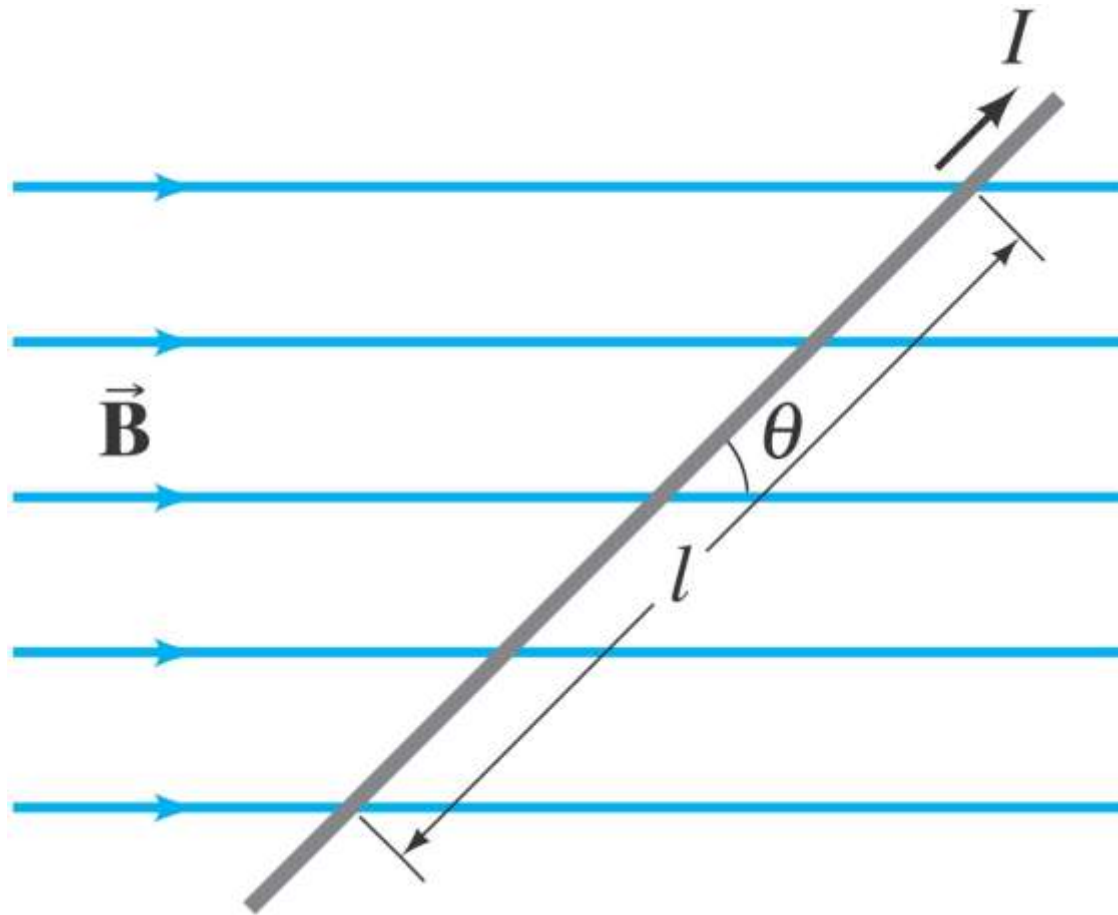

Force on an Electric Current in a Magnetic Field; Definition of B

The force on the wire depends on the current, the length of the wire, the magnetic field, and its orientation.

$$F = IlB \sin \theta \quad \text{(on formula sheet)}$$

If the direction of \mathbf{I} is perpendicular to \mathbf{B} , then $\theta = 90^\circ$ and $\sin \theta = 1$. If \mathbf{I} is parallel to \mathbf{B} , then $\theta = 0^\circ$ and $\sin \theta = 0$. This equation defines the magnetic field \mathbf{B} .

Force on an Electric Current in a Magnetic Field; Definition of B

Unit of B: the tesla, T.

$$1 \text{ T} = 1 \text{ N/A}\cdot\text{m}.$$

Another unit sometimes used: the gauss (G).

$$1 \text{ G} = 10^{-4} \text{ T}.$$

Measuring a magnetic field B

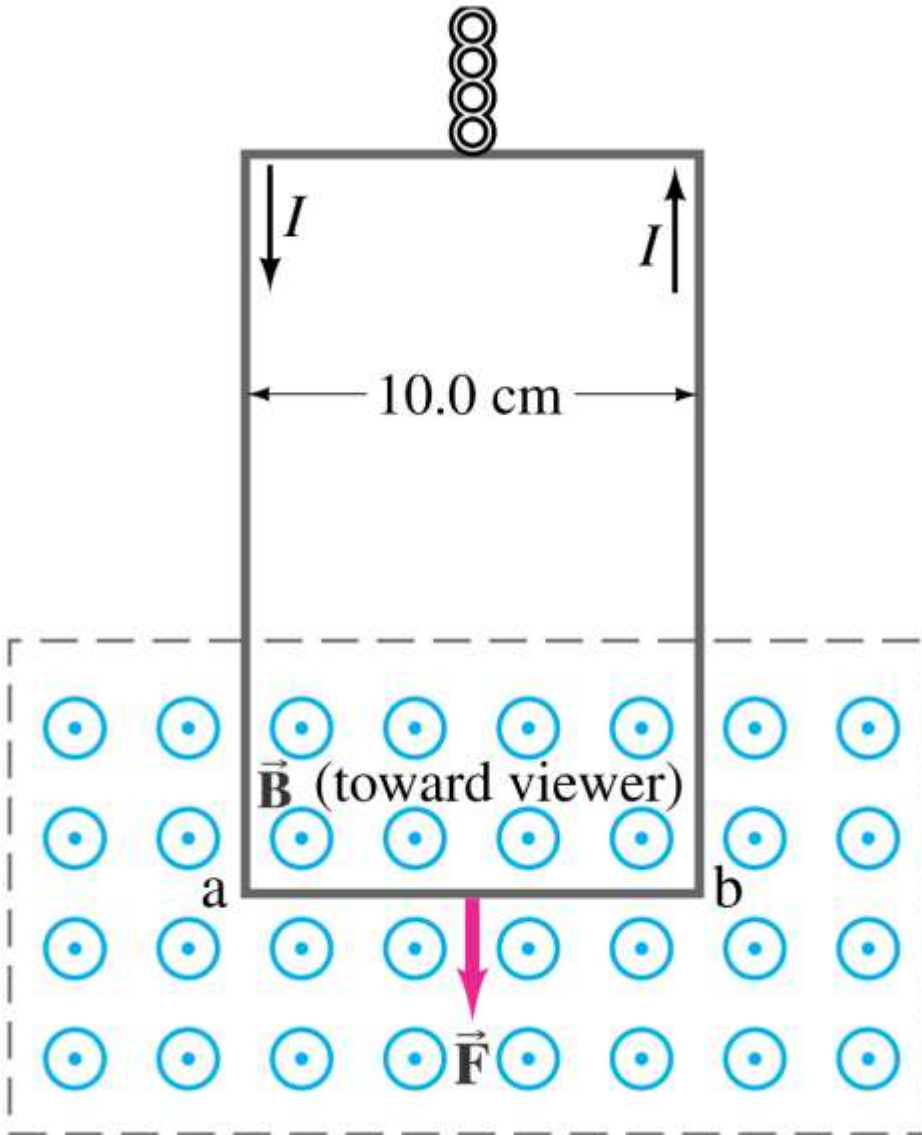

What is the magnetic field if the force is 0.0348 N and the current is 0.245 A? What about the magnetic forces on the two vertical sections of the wire that are in the magnetic field?

Force on Electric Charge Moving in a Magnetic Field

The force on a moving charge is related to the force on a current:

$$F = qvB \sin \theta \quad \text{(on formula sheet)}$$

The force is greatest when the particle moves perpendicular to B ($\theta = 90^\circ$)

Once again, the direction is given by a right-hand rule. The rule is for positive particles. Notice the difference between positive and negative particles.

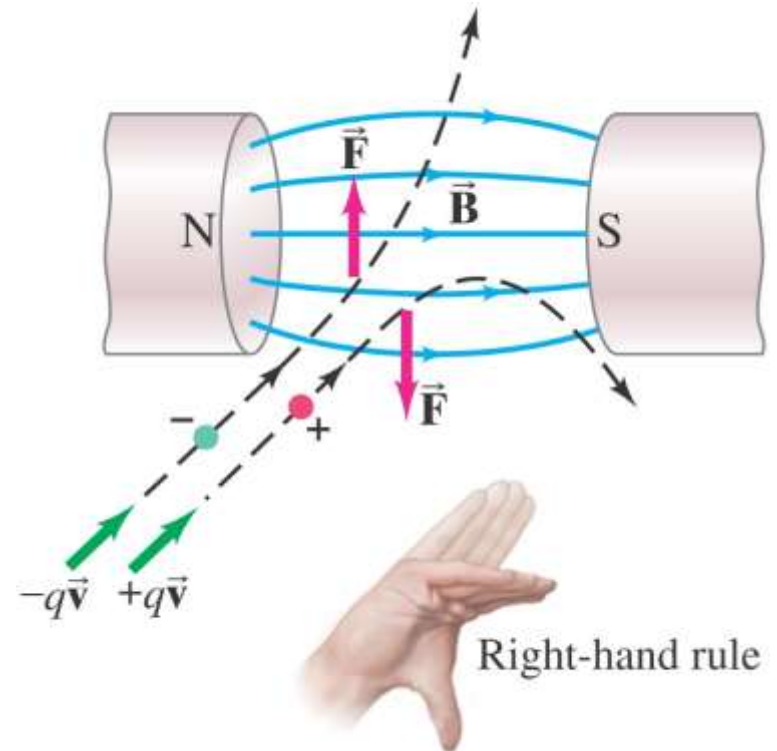

20.4 Force on Electric Charge Moving in a Magnetic Field

If a charged particle (in this case an electron) is moving perpendicular to a uniform magnetic field, its path will be a circle.

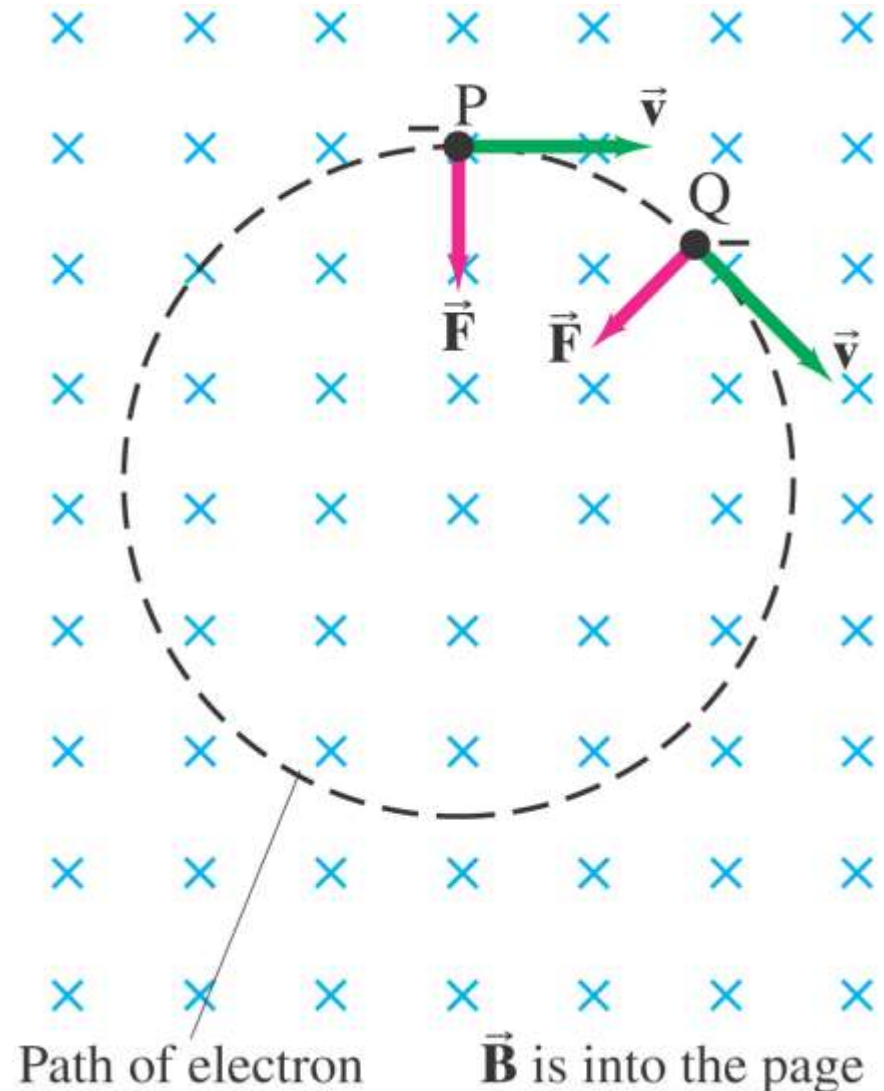

What is the path of a charged particle if its velocity is *not* perpendicular to the magnetic field?

The parallel component of v experiences no force, so it remains constant. The perpendicular component of v results in circular motion. Together this produces a spiral motion.

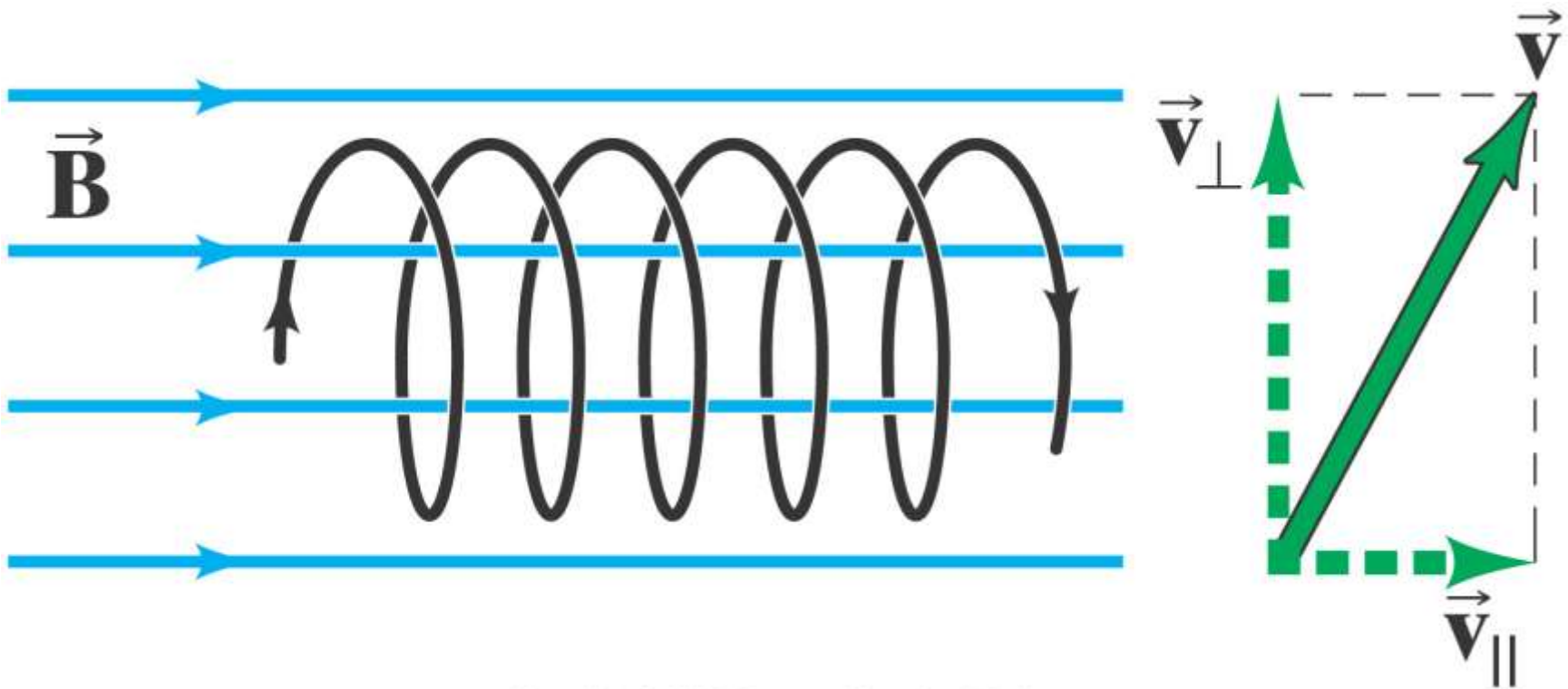

Charged ions approach the Earth from the sun (solar wind) and are drawn toward the poles. This causes the Northern lights.

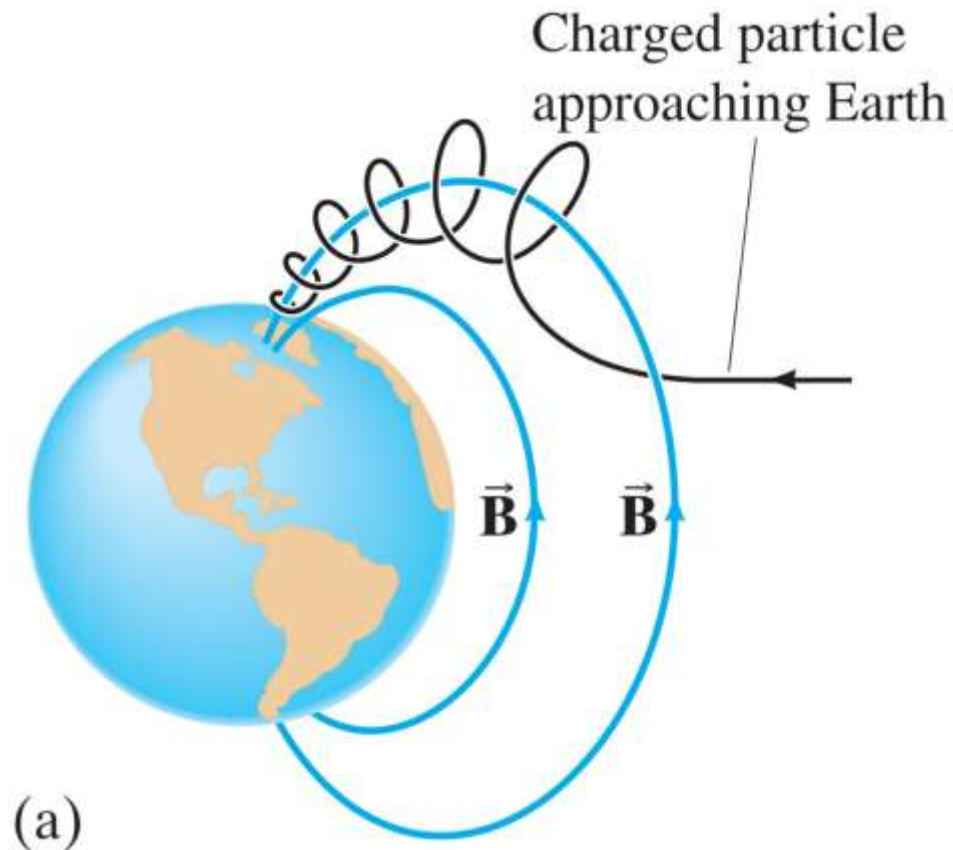

Force on Electric Charge Moving in a Magnetic Field

TABLE 20–1 Summary of Right-hand Rules (= RHR)

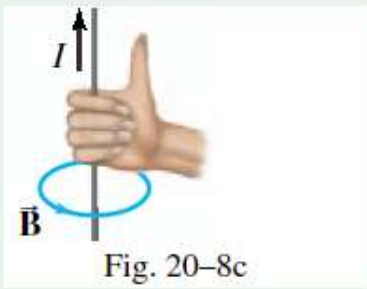
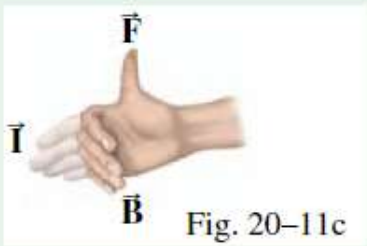
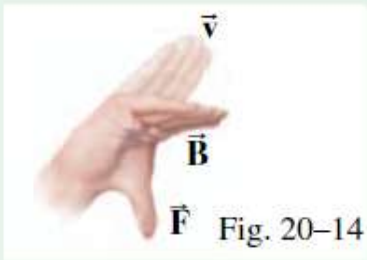
Physical Situation	Example	How to Orient Right Hand	Result
1. Magnetic field produced by current (RHR-1)	 <p>Fig. 20–8c</p>	Wrap fingers around wire with thumb pointing in direction of current I	Fingers point in direction of \vec{B}
2. Force on electric current I due to magnetic field (RHR-2)	 <p>Fig. 20–11c</p>	Fingers point straight along current I , then bent along magnetic field \vec{B}	Thumb points in direction of force
3. Force on electric charge $+q$ due to magnetic field (RHR-3)	 <p>Fig. 20–14</p>	Fingers point along particle's velocity \vec{v} , then along \vec{B}	Thumb points in direction of force

Magnetic Field Due to a Long Straight Wire

The field is inversely proportional to the distance from the wire:

$$B = \frac{\mu_0 I}{2\pi r} \quad \text{(on formula sheet)}$$

The constant μ_0 is called the permeability of free space (or Vacuum permeability), and has the value:

$$\mu_0 = 4\pi \times 10^{-7} \text{ T}\cdot\text{m/A}$$

Force between Two Parallel Wires

The magnetic field produced at the position of wire 2 due to the current in wire 1 is:

$$B_1 = \frac{\mu_0 I_1}{2\pi d}$$

The force this field exerts on a length l_2 of wire 2 is:

$$F_2 = \frac{\mu_0 I_1 I_2}{2\pi d} l_2 \quad (20-6)$$

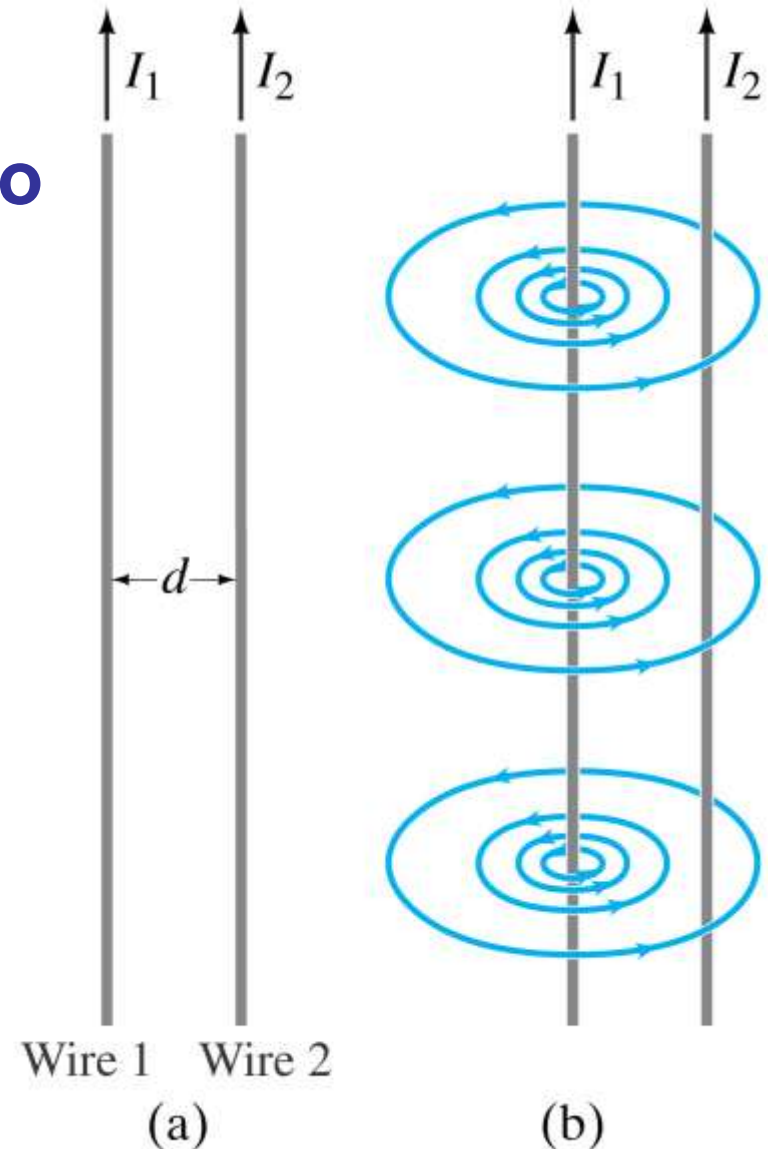

Force between Two Parallel Wires

Parallel currents attract; antiparallel currents repel.

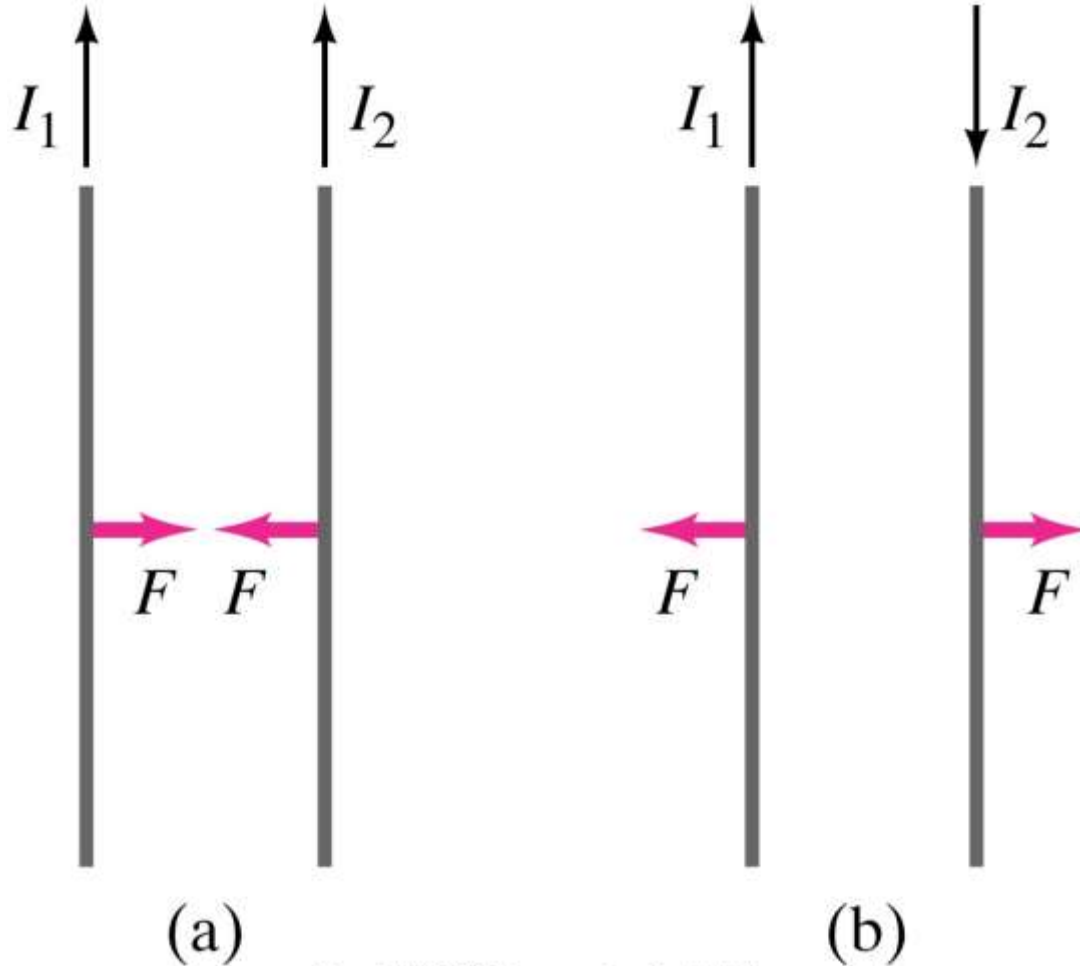

Solenoids and Electromagnets

If a piece of iron is inserted in the solenoid, the magnetic field greatly increases. Such electromagnets have many practical applications.

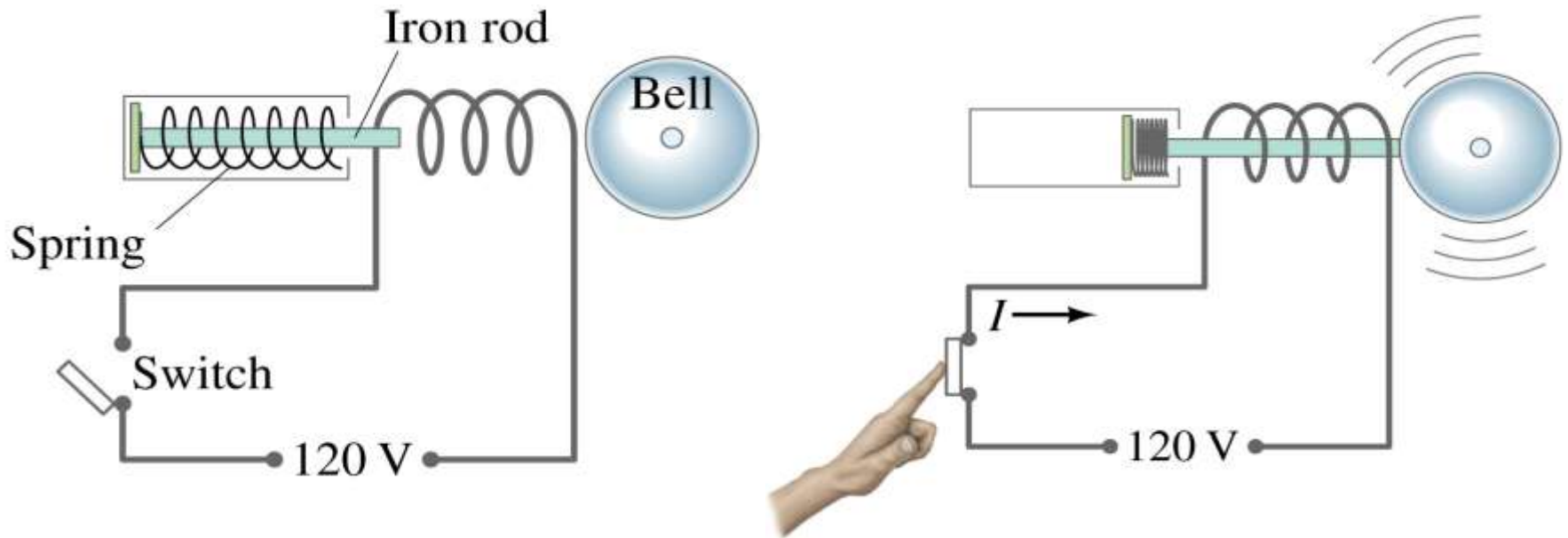

Electromagnetic Induction

The effect of producing an induced current is known as **electromagnetic induction**. The direction of the induced current can be reversed by reversing the motion of the wire or reversing the field direction. The strength of the current depends on the strength of the magnetic field and the speed of the wire's motion.

[Induction Movie](#)

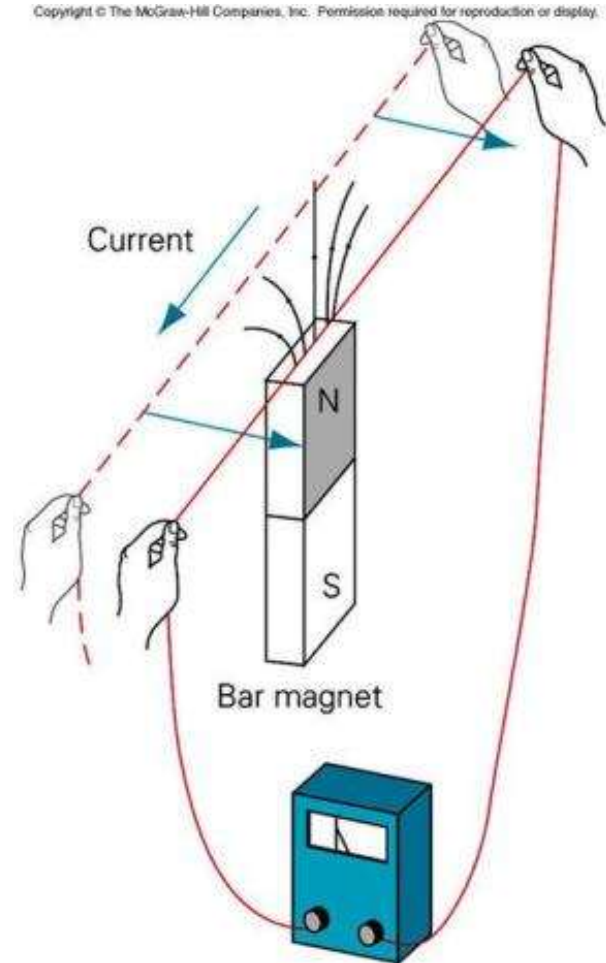

Electromagnets

An **electromagnet** consists of an iron core placed inside a wire coil. The magnetic field strength of a wire coil carrying an electric current increases in direct proportion to the number of turns of the coil.

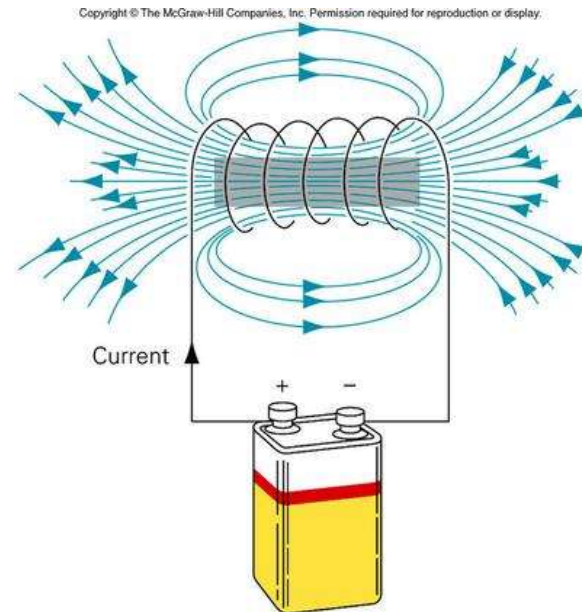
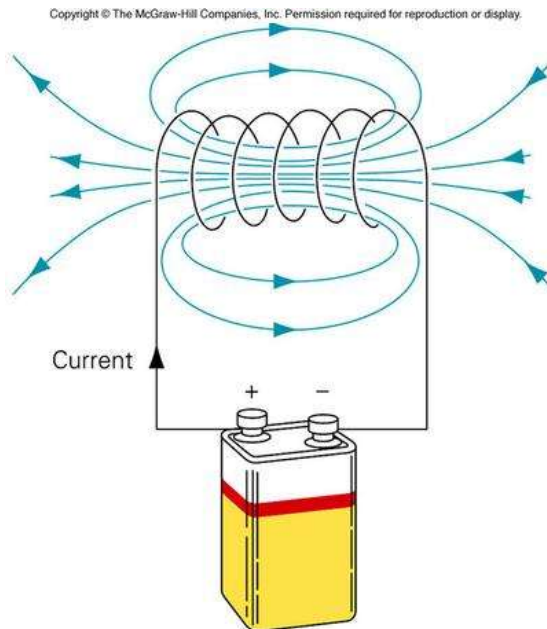

Electric Motors

An electric motor uses the sideways push of a magnetic field to turn a current-carrying wire loop. Electric motors use a **commutator** to change the direction of the current in the loop. Alternating current electric motors do not use commutators.

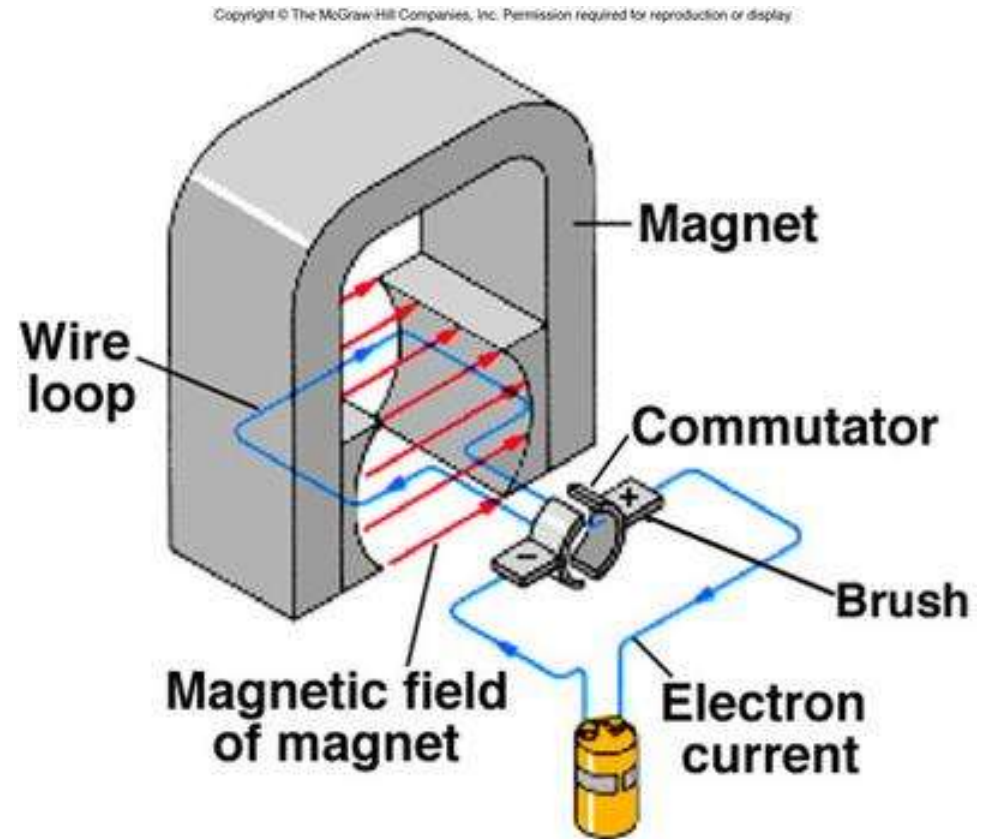

Applications: Motors & Loudspeakers

An electric motor takes advantage of the torque on a current loop, to change electrical energy to mechanical energy.

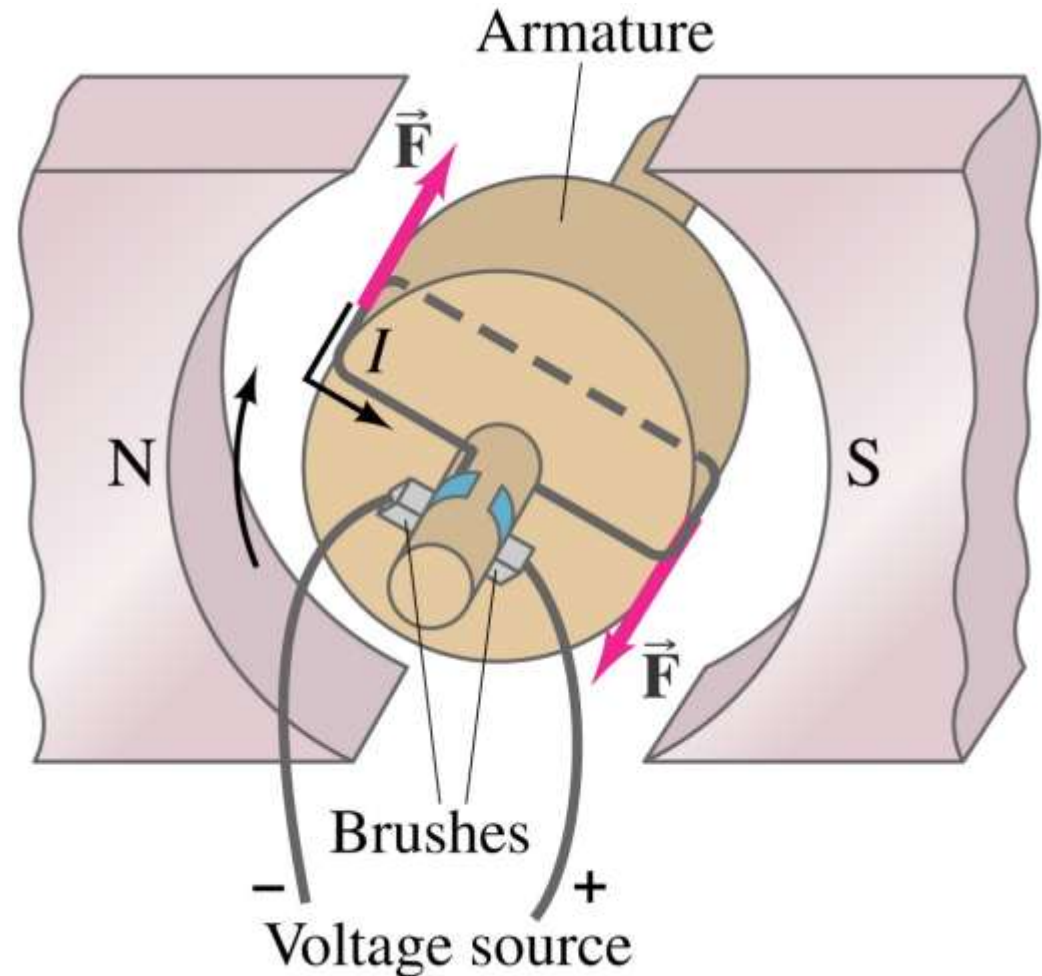

Applications: Motors & Loudspeakers

Loudspeakers use the principle that a magnet exerts a force on a current-carrying wire to convert electrical signals into mechanical vibrations, producing sound.

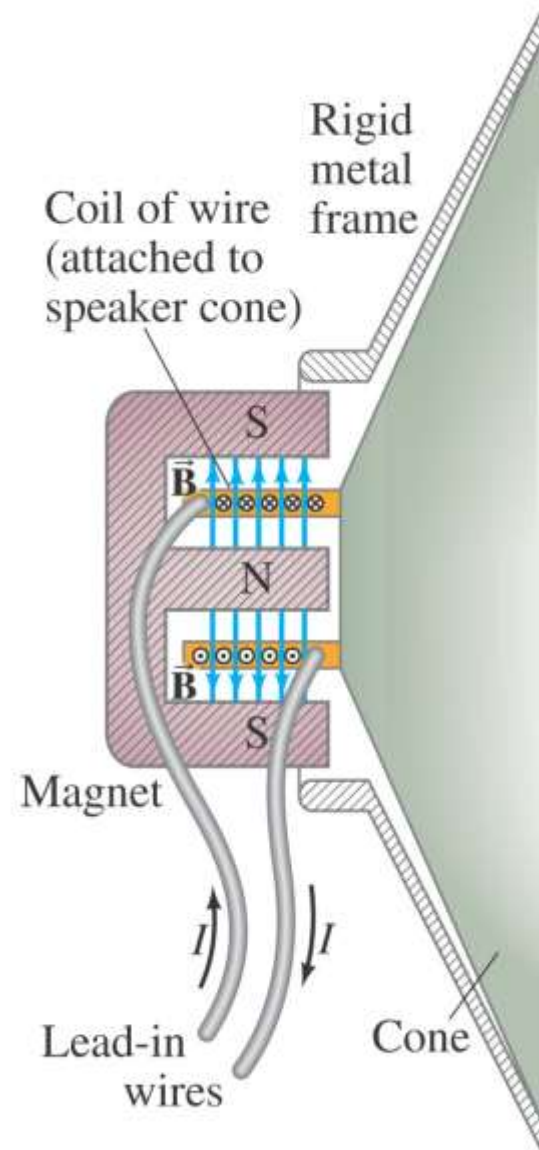

Alternating and Direct Current

Alternating current (ac) is current that flows in a back-and-forth manner; household current changes direction 120 times each second (60 Hz). **Direct current (dc)** flows in one direction.

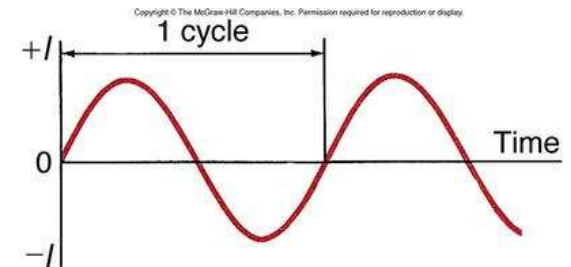
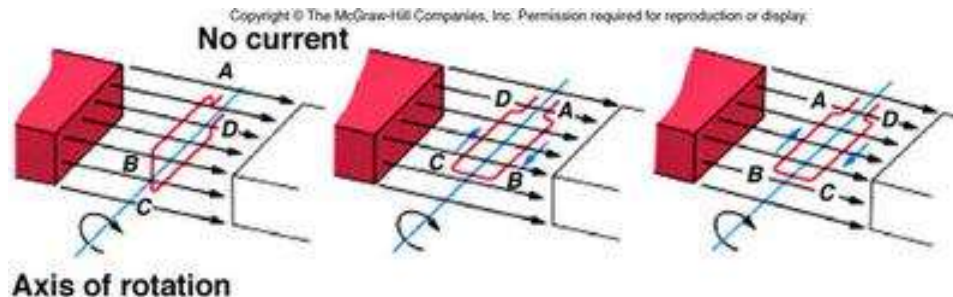

The ac generator (or alternator) produces an ac current and can be modified to produce dc current by

1. Use of a **commutator**.
2. Use of a **rectifier** which permits current to pass through it in only one direction.

Transformers

A **transformer** is a device composed of two unconnected coils, usually wrapped around a soft iron core, that can increase or decrease the voltage of ac current.

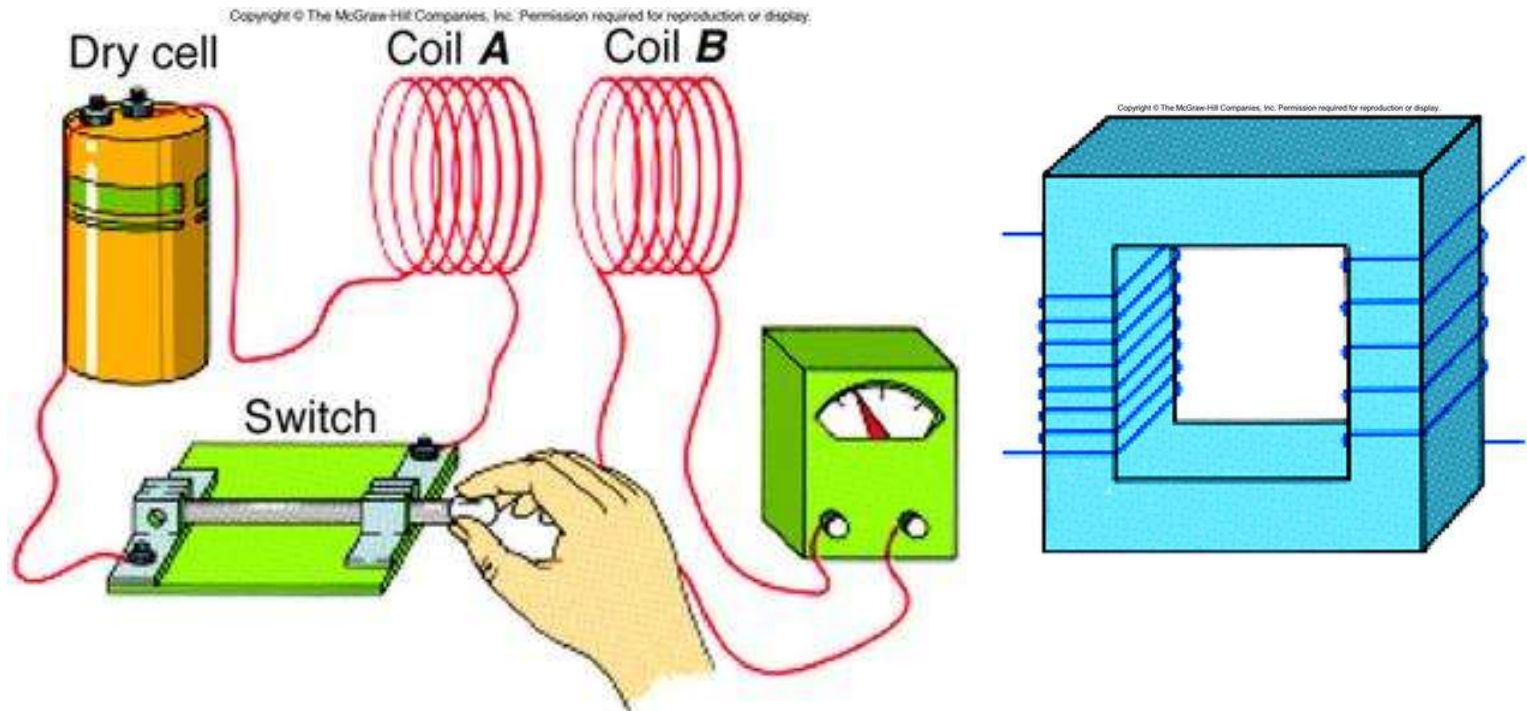

Transformers

A **transformer** is used to step the voltage down and the current up ($P=IV$) so that we can use it. Low power is desired for the transport of electricity long distances to avoid loss of energy to heat loss. Transformers must use AC current.

A moving coil activated by voice vibrations is used as a microphone. The coil induces a current in the magnet that can be amplified or recorded.

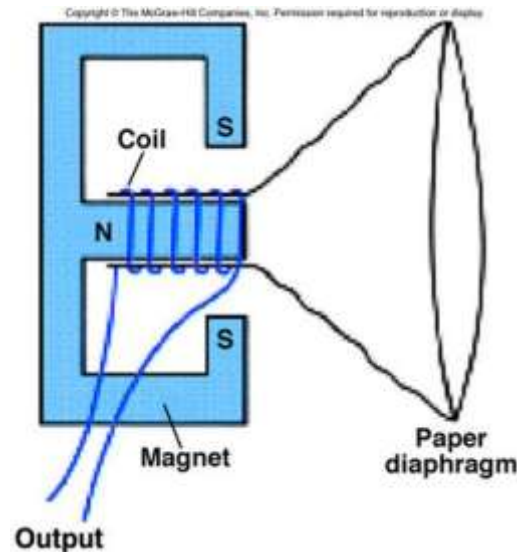

Transformers

A **taperecorder** records signals from a microphone on magnetic tape which then can be run across a magnet and played back.

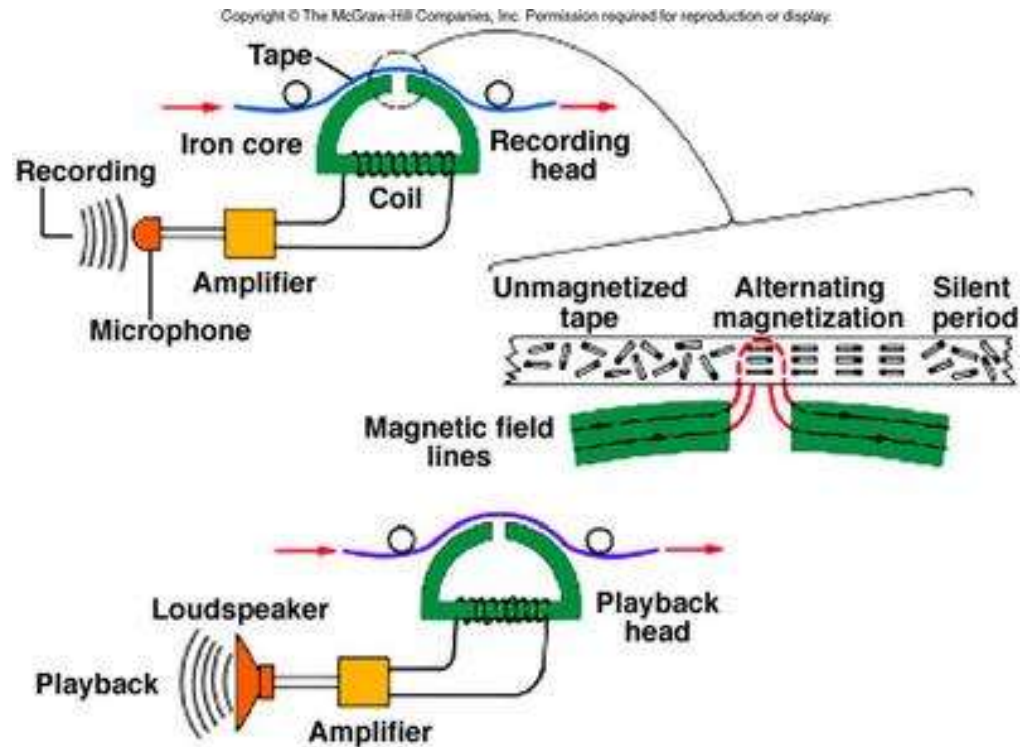

Electromagnets

An electromagnet consists of a current carrying coil wrapped around an iron core.

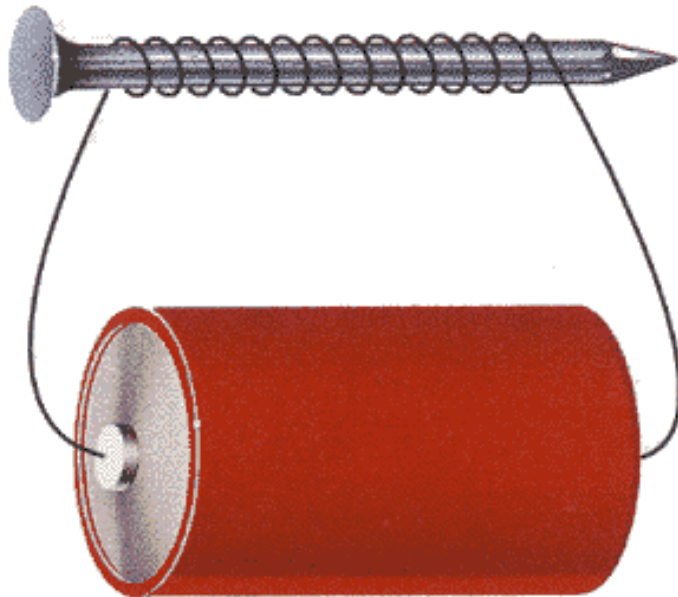

Uses of electromagnets

1. Scrap yard crane

The iron core of the electromagnet is a **SOFT** magnetic material.

When current flows the iron becomes strongly magnetised and so picks up the scrap iron and steel.

When the current is turned off the iron loses its magnetisation and so releases the scrap.



The electric bell

When the push switch is closed current flows around the circuit turning on the **electromagnet**.

The **soft iron armature** is pulled towards the electromagnet and the hammer hits the gong.

This causes the **contact switch** to open cutting off the electric current.

The **spring** now pulls the armature back again closing the contact switch.

Current now flows again and the hammer hits the gong again.

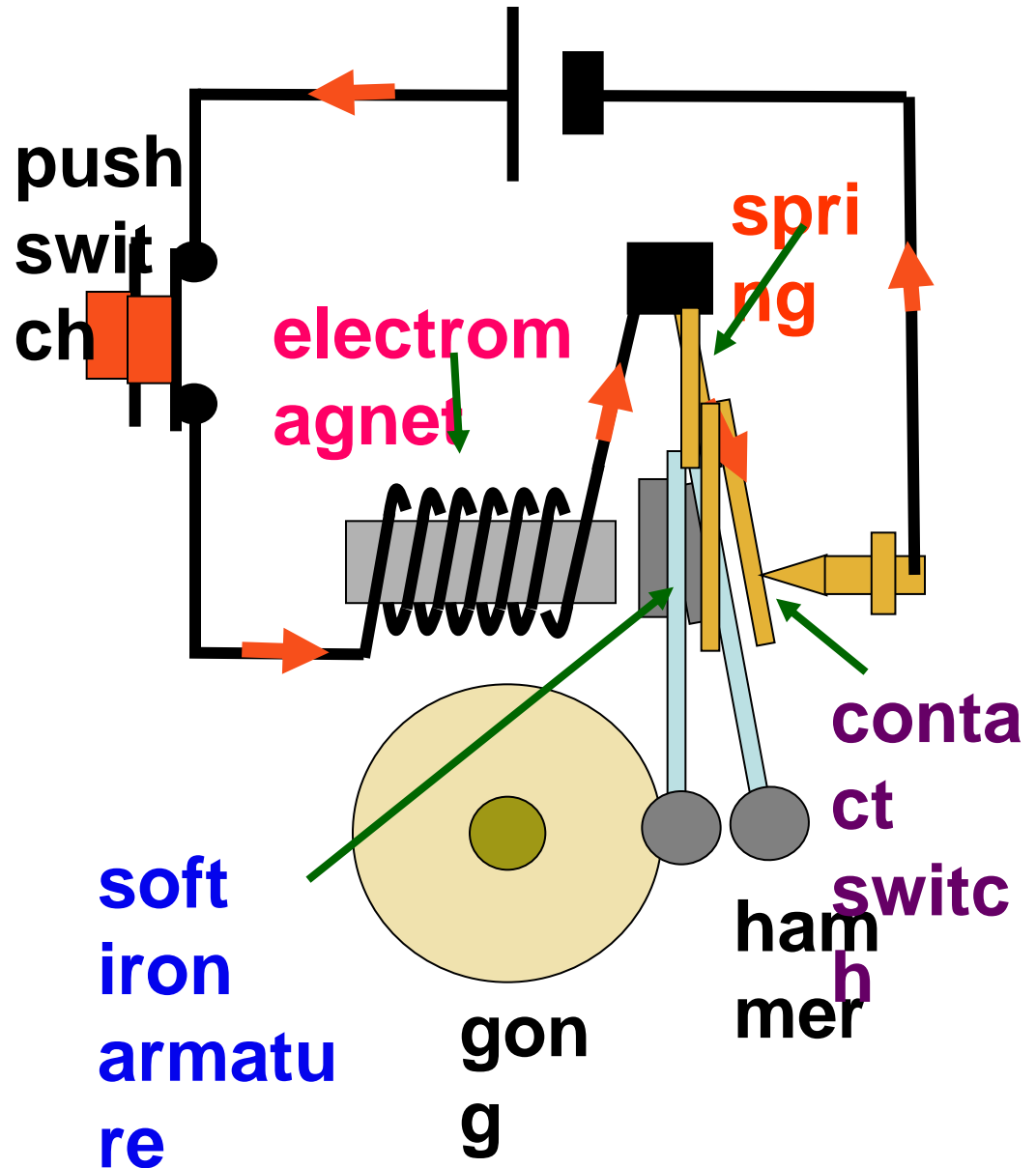

Label the diagram of the electric bell below:

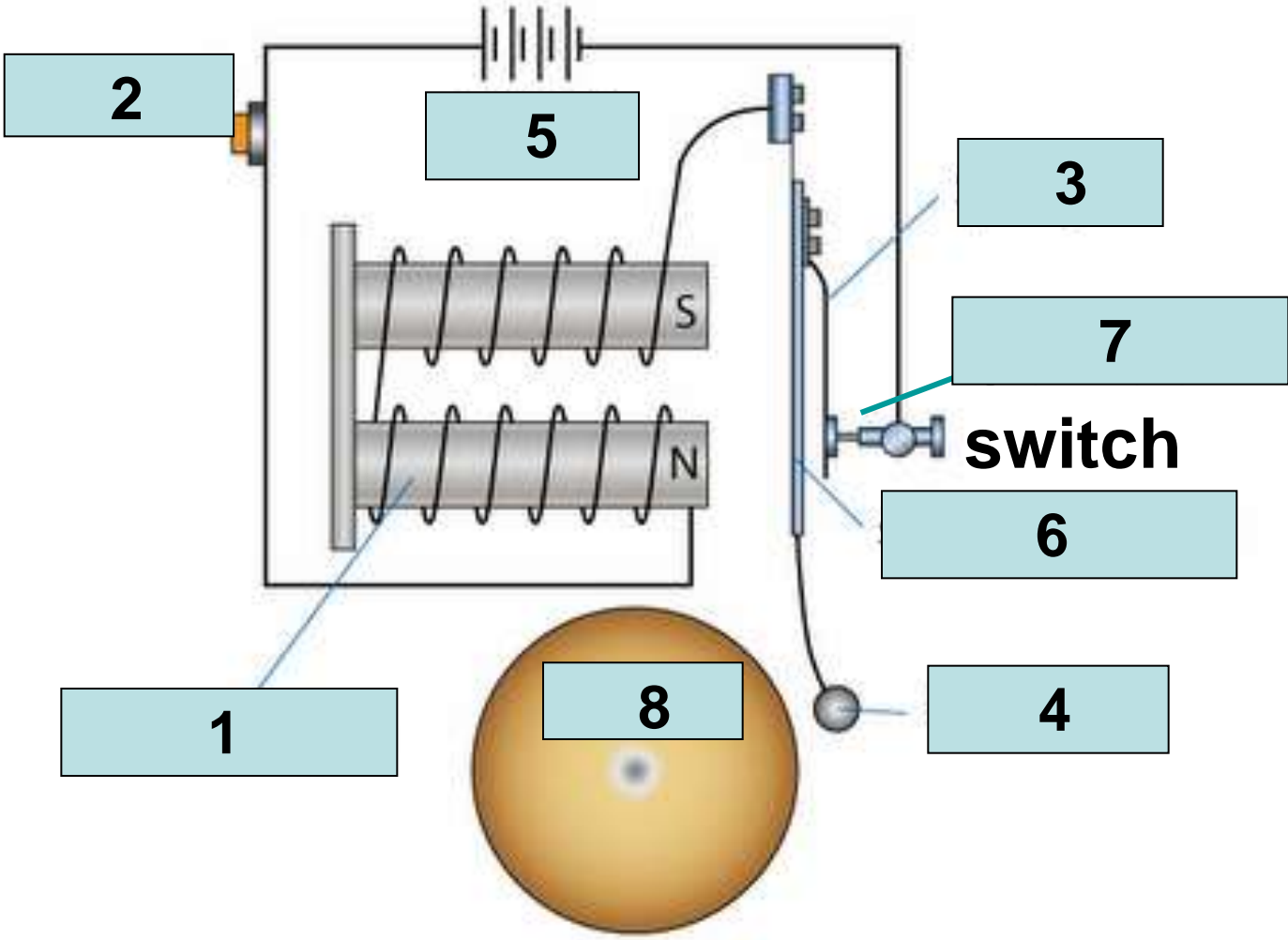

The relay switch

A relay switch is a way of using a low voltage circuit to switch remotely a high voltage (and possibly dangerous) circuit.

When switch A is closed, the small current provided by the cell causes the electromagnet to become magnetised..

The iron armature is then attracted to the electromagnet causing the springy contact switch B to close in the high voltage circuit.

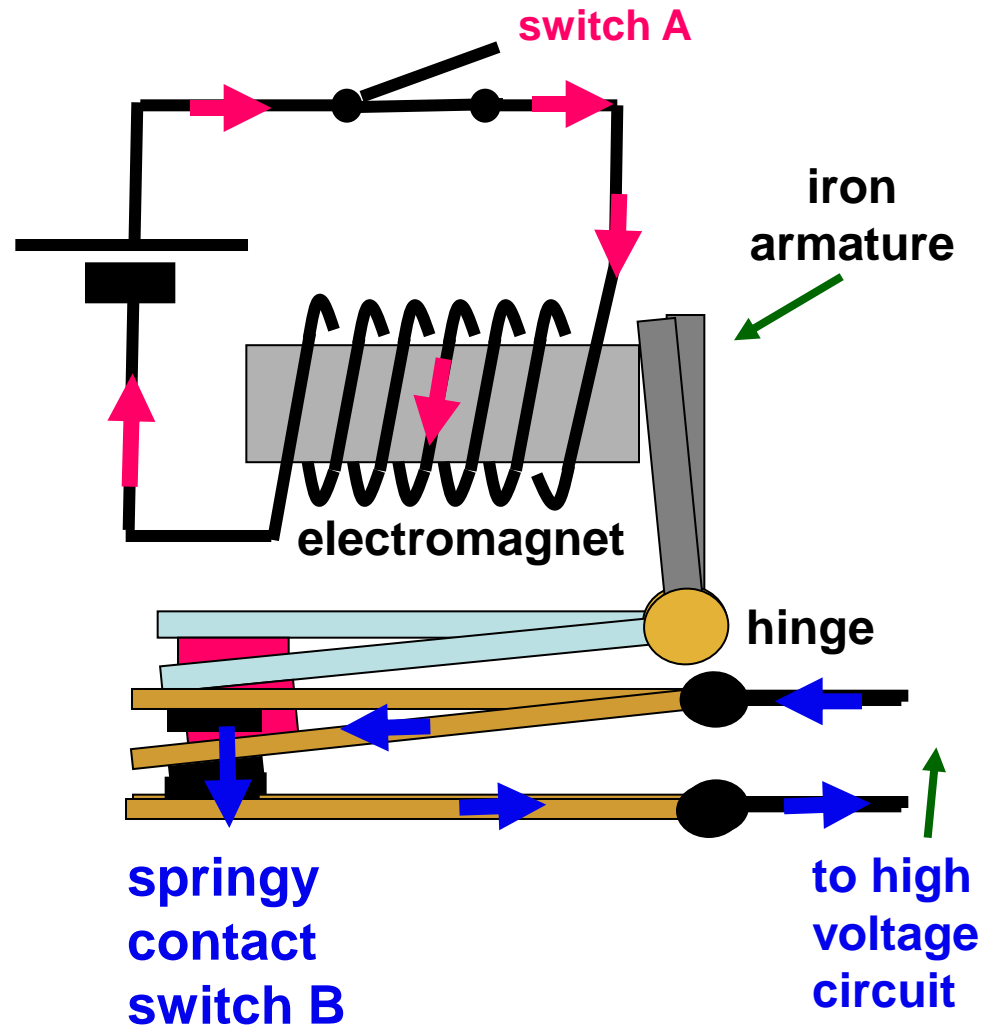

4. Circuit breaker

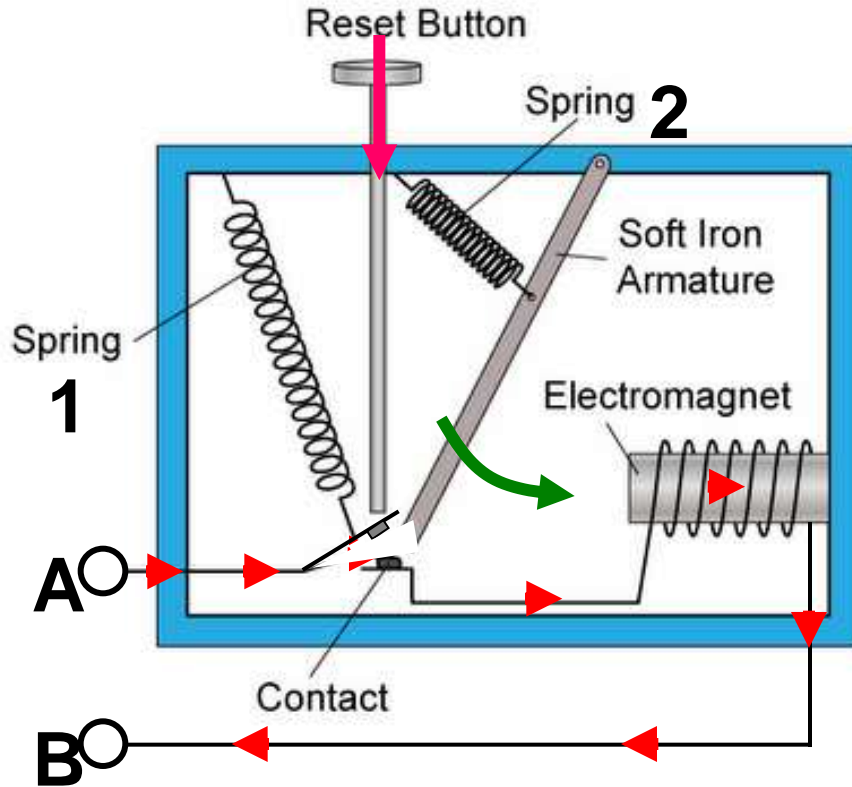

Current normally flows between terminals **A** and **B** through the contact and the electromagnet.

When the current in a circuit increases, the strength of the electromagnet will also increase. This will pull the soft iron armature towards the electromagnet.

As a result, spring 1 pulls apart the contact and disconnecting the circuit immediately, and stopping current flow.

The reset button can be pushed to bring the contact back to its original position to reconnect the circuit



Domestic circuit breakers

Electromagnetic Radiation

Electromagnetic waves travel through empty space at a speed of 300,000 km/s (186,000 miles/sec).

EM waves with wavelengths 400-700 nm are seen by the human eye as **Visible Light**.

